

User's Manual**SPENCER SHELL
Universal basket stretcher**

This appliance conforms with the directive 93/42/CEE "Medical Devices".

Guarantee of Quality system for the production and the final control of the products certified by the notifying body TÜV Product Service GMBH.

INDEX

General Information	page 2	Operating Instructions	page 4
Warnings	page 2	Maintenance and Cleaning	page 6
Description of Product	page 3	Accessories and Replacements parts	page 7

Thank you for choosing a Spencer product

1 GENERAL INFORMATION

1.1 AIM AND CONTENTS

The aim of this manual is to supply all the information necessary so that the client, apart from attaining an adequate use of the appliance, will also be capable of using the instrument in the most autonomous and secure way possible. This includes information regarding technical aspects, functioning, maintenance, spare parts and safety.

1.2 CONSERVATION OF THE INSTRUCTION MANUAL

The instruction and maintenance manual must be kept with the product, inside the specially provided container and above all, away from any substances or liquids which could compromise perfect legibility.

1.3 SYMBOLS USED

SYMBOL	MEANING
	See instructions for use

1.4 SERVICING REQUESTS

For any information regarding the use, maintenance and installation, please contact the Spencer Customer Care Service on 0039 0521 541111 - Fax 0039 0521 541222 e-mail: info@spencer.it or write to Spencer Italia S.r.l. - Strada Cavi, 7 - 43044 Collecchio (Parma) - ITALY.

1.5 DEMOLITION

Follow the current regulations.

1.6 LABELLING

The serial number as indicated below can be found on each appliance and must not be removed or covered. In order to facilitate assistance please indicate or communicate the serial number (SN) or lot number (LOT) on the label.

2 WARNINGS

2.1 GENERAL WARNINGS

- Before carrying out any kind of operation on the appliance, the operator must carefully read the enclosed instructions, paying particular attention to the correct safety precautions and to the procedures to be followed for installation and for correct use.
- In the case of any doubts as to the correct interpretation of the instructions, please contact Spencer Italia S.r.l., for any necessary clarifications.
- Regularly check the appliance. Carry out the prescribed maintenance in order to keep the appliance in good condition and to guarantee correct functioning and a long life.
- In the case of any abnormalities or damage to the appliance, which could jeopardize the functioning, and the safety, the appliance must be immediately removed from service.
- Do not alter or modify in any way the appliance; any such interference could cause malfunctions and injury to the patient and/or rescuer.
- The appliance must not in any way be tampered with, in such cases all responsibility will be denied for any malfunctions or eventual injuries caused by the appliance itself.
- Who modifies or has modified, prepares or has prepared medical appliances in such a way that they no longer serve the purpose for which they were intended, or no longer supply the intended service, must satisfy the valid conditions for the introduction onto the market.
- Ensure that all the necessary precautions are taken in order to avoid hazards that can arise as the result of contact with blood or body fluids.
- Handle with care.

2.2 SPECIFIC WARNINGS

- This product should be used only by adequately trained staff.
- Follow the approved EMS procedures for the restraint and transport of patients. Failure to do so could cause serious harm to the patient.
- This device is designed for use by at least 2 operators in good physical condition.
- The patient must always be immobilised on the SPENCER SHELL stretcher.
- Do not use if the weight of the patient is not evenly distributed.
- Do not exceed the maximum loading weight and follow the maintenance guide indicated in this instruction manual.
- Do not leave the patient unassisted on the stretcher.
- The product should not be exposed or come into contact with sources of heat or inflammable agents.

2.3 PHYSICAL REQUIREMENTS FOR OPERATORS

SPENCER SHELL is a stretcher which should be used exclusively by trained professionals.

Those operating with it must have the following minimum requirements:

- Have the physical strength to use the stretcher
- Be able to tightly hold the stretcher with each hand
- Have a generally good muscular condition

2.4 CONTRAINDICATIONS AND SIDE EFFECTS

The use of this device, if used as described in this manual, does not present any contra-indications or collateral effects.

3 DESCRIPTION OF PRODUCT

3.1 INTENDED USE

The SPENCER SHELL basket stretcher is a device designed for the rescue and transport of patients. It can be used in all rescue operations in which it is impossible to intervene with the standard transport methods and where the patient needs protection from possible side impact.

This device can be used for helicopter transport.

It is not designed for any intervention on behalf of the patient.

3.2 MAIN COMPONENTS

1. High density, bump proof polyethylene shell
2. Closed cell impermeable polypropylene foam mattress
3. No seam adjustable foot rest in cross linked polyethylene
4. Three 50 mm nylon belts with rapid buckle up system (four belts for model ST04061A)
5. 10 mm polyester rope for safety belts and footrest fixation

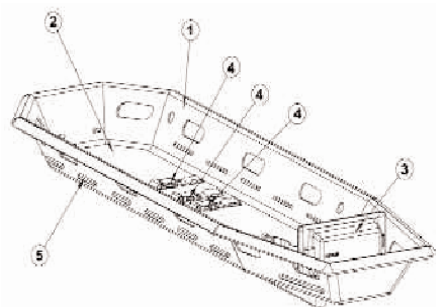

Fig. A

3.3 MODELS

ST04012A	SPENCER SHELL Universal basket stretcher yellow with 3 belts
ST04000A	SPENCER SHELL Universal basket stretcher orange with 3 belts
ST04017A	SPENCER SHELL Universal basket stretcher red with 3 belts
ST04001A	SPENCER SHELL Universal basket stretcher military with 3 belts
ST04061A	SPENCER SHELL Universal basket stretcher orange with 4 belts

3.4 TECHNICAL DATA

Length	2150 mm
Width	650 mm
Height	190 mm
Load capacity	280 kg
Weight	13,5 kg
Number of handles	12
Material shell	high density polyethylene

3.5 ENVIRONMENTAL CONDITIONS

Functioning temperature: from -10 to +50 °C

Storage temperature: from -10 to +50 °C

Relative humidity: from 5 to 95%

4.1 TRANSPORT AND STORAGE

Before transporting the appliance, make sure that it is correctly packaged ensuring also that there are no risks of shocks or falls during the transport itself.

Keep the original packaging for any eventual further transport. Damage to the appliance caused during transport and handling is not covered by the guarantee. Repairs or replacement of the damaged parts are the responsibility of the Client. The appliance must be stored in a dry place free from humidity.

4.2 PREPARATION

On receipt of the product:

- Remove packaging and layout all components so they are clearly visible
- Check that all parts indicated on the shipping document are present
- Check that the product is correctly assembled and that all the rivets are tight
- Attach the safety belts by knotting them to the perimeter rope (fig. B, C)

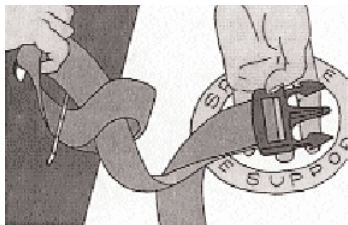

Fig. B

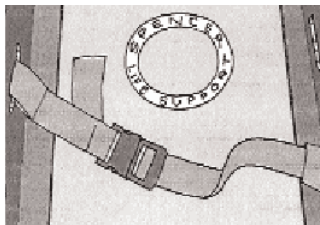

Fig. C

The device must be checked each time before use so that any function faults and / or damage caused during transport and/or during storage are detected.

Each time before use:

- Check that the perimeter rope is tight
- Check that the safety belts are correctly attached and adapt for immobilising the patient
- Make sure that the footrest is in position

If no faults are found, the stretcher is ready for use. If you require any further details regarding the routine checking, please contact the Spencer Customer Service (paragraph 1.4).

If the stretcher presents any faults which you consider may compromise its correct and safe use, it must be immediately removed from service and you must contact the Spencer Customer Service.

4.3 FUNCTIONING

Follow the specifications approved by the EMS service for the restraint and transport of the patient. The instructions in this manual must be read carefully before use.

Practice and training should be done with the stretcher without a patient so that the operators have familiarity with manoeuvring before regular use in emergency situations.

4.3.1 PATIENT LOADING

1. Get as close as possible to the patient before loading.
2. Load the trauma patient using the standard immobilising devices: spine board, vacuum mattress, etc.

4.3.2 FOOTREST SYSTEM

1. Position the footrest (fig. D) in the correct position so that the flat surface is in contact with the patients feet and the patient is comfortably blocked on the longitudinal axis.
2. Insert the buckles on the end of the belts through the button holes/handles on the perimeter of the SPENCER SHELL (fig. E).
3. Check that the footrest is centred correctly, the belts correctly attached and that it maintains a position perpendicular to the base of the stretcher (fig. F).

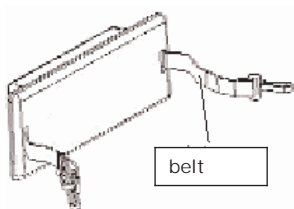

Fig. D

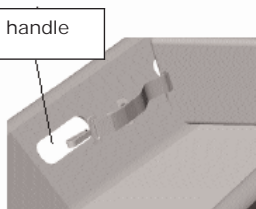

Fig. E

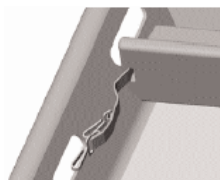

Fig. F

4.3.3 LIFTING THE STRETCHER WITH A PATIENT ON BOARD

1. Restrain the patient in the SPENCER SHELL using the supplied belts (fig. G).
2. Check that the belts are not too tight.
3. The operators must be positioned at the ends of the stretcher, one in head area the other by the feet.
4. Using a correct lifting technique which will avoid excessive strain, each operator should take a strong grasp of the handholds at each end of the basket and lift.

4.3.4 LOADING OF THE BASKET STRETCHER ONTO THE AMBULANCE OR OTHER ADAPT VEHICLE

Position the stretcher in the purpose made allotments.

4.3.5 UN-LOADING OF THE BASKET STRETCHER ONTO THE AMBULANCE OR OTHER ADAPT VEHICLE

Remove any fastening devices used to fix the basket. Grasp the handholds and remove from the vehicle.

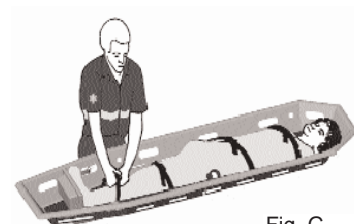

Fig. G

4.3.6 TRANSPORT ON INCLINED/SLOPING GROUND

1. Correctly position the footrest so that the patient will not move up and down.
2. If the patient has leg injuries, immobilise with the correct device and do not upright the SPENCER SHELL.
3. Secure the stretcher with a static safety system before lifting or descending.
4. The patient must always be assisted during manoeuvres.

4.3.7 VERTICAL TRANSPORT

1. Correctly position the footrest so that the patient does not move.
2. If the patient has any leg injuries, immobilise with the appropriate device and do not upright the SPENCER SHELL stretcher.
3. After immobilising the patient use the lifting bridle system STX 519 (code ST04519C) or STX 540 (code ST04522B) fixing them to the 4 aluminium buttonholes on the shell of the stretcher.
4. After adjusting the length of the lifting bridle so as to maintain correct horizontal position, lift the stretcher vertically using the hook of the system STX 519 or STX 540.
5. The patient must always be assisted during all manovres.

4.4 TROUBLESHOOTING

PROBLEM	CAUSE	REMEDY
Damage to the shell	Improper use	Immediately remove the device from service and contact the Customer Care Service
Damage to the rivets around the perimeter	Improper use	Immediately remove the device from service and contact the Customer Care Service

5 MAINTENANCE AND CLEANING

5.1 CLEANING

Clean exposed parts with a sponge and delicate detergent then dry with a soft cloth or chammy leather. The mattress inside the SPENCER SHELL can be cleaned using soap and water and disinfected using a normal disinfectant. Failure to carry out the cleaning procedure could result in cross contamination caused by residuals of secretions or body liquids. We recommend the use of STX 98 detergent (code ST50010C) for correct cleansing of the polyethylene shell.

5.2 MAINTENANCE

5.2.1 Precautionary Maintenance

The correct and routine cleaning of the stretcher will guarantee it a longer life time. When the stretcher is put into service, a maintenance and check up routine should be arranged and a person responsible for its execution should be identified.

Checks to perform:

- The structure of the stretcher
- Wearing on the belts, mattress and perimeter rope
- Rivets around perimeter being tightly and correctly attached
- Check the correct attachment of the grommets for the lifting bridle

The device does not require periodical servicing.

5.2.2 Special servicing

Only the manufacturer or centres with written authorisation are authorised to complete any special servicing operations.

The device, if used as described in the following instructions, has a life span of 5 years.

6 ACCESSORIES AND REPLACEMENT PARTS**6.1 ACCESSORIES**

STX 537 Single piece Universal float	ST04525B
STX 518 Two part Universal float i	ST04518A
STX 538 Three part Universal float	ST04524B
STX 519 Adjustable lifting bridle	ST04519C
STX 540 Fixed lifting bridle	ST04522B
STX 542 Towing belts	ST04523B
Speed Basket mini Wheels	ST04600B
Speed Basket mega Wheels	ST04601B
STX 40 Transport bag	ST04040A
Track 5 IV Holder	IF01059B
Shell Matt Vacuum mattress	ST04526B
Progrip Handles	ST04521B
Spencer Rock Spine board yellow	ST02031A
Spencer Rock Spine board orange	ST02030A
Spencer Rock Spine board red	ST02033A
Spencer Rock Spine board green	ST02032A
Spencer Rock Spine board military	ST02036A
Spencer Contour Universal head immobilizer yellow/black	SH00201A
Spencer Contour Universal head immobilizer blue	SH00200A
FXA Universal ankle restraint	SH00150A
FXA Pro Anatomical universal ankle restraint	SH00151A
Spencer 550 Padded nylon blanket	ST00550A

6.2 SPARE PARTS

Footrest	ST04011A
STX 598 Two piece belt with plastic buckle	ST00598A
Perimeter rope	ST04029A

Warning

The information contained in this document can be modified without warning and is not to be intended as a commitment on the part of Spencer Italia S.r.l. Spencer products are exported to many countries in which the same identical regulations do not exist. It is for this reason that there can be many differences between the description and the actual product delivered. Spencer works continuously to reach the perfection of all the models sold. We therefore hope to have your understanding if we reserve the right to modify the shape, equipping, lay-out or technical aspects that are herein described, at any given time.

© Copyright Spencer Italia S.r.l.

All rights reserved. No part of this document must be photocopied, reproduced or translated into another language without the written approval of Spencer Italia S.r.l.