

---

**LETTINI VISITA BASIC**  
**ECONOMIC EXAMINATION BEDS**  
**LITS D'EXAMEN BASIC**  
**UNTERSUCHUNGSBETT BASIC**  
**CAMILLAS DE EXAMEN BASIC**  
**MARQUESAS DE VISITA BASIC**

---

- È necessario segnalare qualsiasi incidente grave verificatosi in relazione al dispositivo medico da noi fornito al fabbricante e all'autorità competente dello Stato membro in cui si ha sede.
- All serious accidents concerning the medical device supplied by us must be reported to the manufacturer and competent authority of the member state where your registered office is located.
- Il est nécessaire de signaler tout accident grave survenu et lié au dispositif médical que nous avons livré au fabricant et à l'autorité compétente de l'état membre où on a le siège social.
- Jeder schwere Unfall im Zusammenhang mit dem von uns gelieferten medizinischen Gerät muss unbedingt dem Hersteller und der zuständigen Behörde des Mitgliedsstaats, in dem das Gerät verwendet wird, gemeldet werden.
- Es necesario informar al fabricante y a la autoridad competente del Estado miembro en el que se encuentra la sede sobre cualquier incidente grave que haya ocurrido en relación con el producto sanitario que le hemos suministrado.
- É necessário notificar ao fabricante e às autoridades competentes do Estado-membro onde ele está sediado qualquer acidente grave verificado em relação ao dispositivo médico fornecido por nós.



**ATTENTION!** The operators must carefully read and completely understand the present manual before using the product

## INTRODUCTION

In accord with Regulation (EU) 2017/745, this product is part of the CLASS I MEDICAL DEVICES. You should carefully read this manual before using this medical device.

## DESCRIPTION

The economic examination couch is designed for hospitals, community centers, nursing homes and medical offices. It has small dimensions; the mattress is washable and fireproof; it's composed of two parts, one fixed and another one reclining in different positions. Depending on the model, the structure can be painted or chromed-plated.

- **Chromed or painted structure, made by legs, structure and backrest.**
- **Mattress covered with washable and fire-retardant fabric.**
- **On request: couch roll holder.**

## COMPONENTS:

- N. 2 legs
- N. 1 backrest crosspieces ▲
- N. 3 crosspieces without holes ☆
- N. 2 crosspiece with hole ●
- N. 1 long crosspiece ◆
- Back padding
- Seat padding

## Assembly material:

- N. 16 SCREWS TBE 8 x 50
- N. 18 WASHERS M8
- N. 6 CHIPBOARD SCREWS TPS 4,5 x 45 (to fix the mat to the frame)
- Allen key 5 mm

## ASSEMBLY INSTRUCTIONS:

The couch is completely disassembled.

**Be careful to use the correct crosspieces following the symbology.**

- 1. Take the two legs of the couch and assembly with five crosspiece by screws and washers.*
- 2. Take the long crosspiece and fix it to the two perforated crosspieces that you have already been fixed to the legs.*
- 3. Fix the crosspiece to the structure with the head support rod already mounted to the padding of the backrest using a hexagonal screw and relative nut.*

4. Finally fix the pads to the frame using screws.

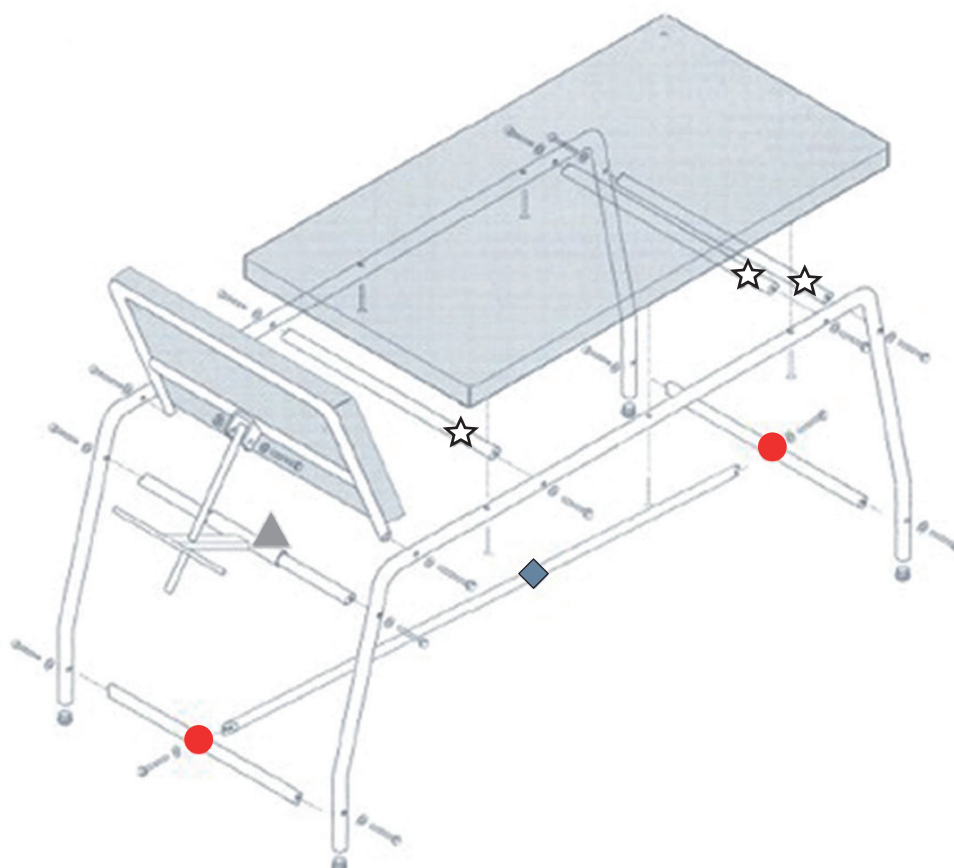

## TECHNICAL DATA

<b>Measurement</b>	191 x 62 x 73 cm
<b>Weight</b>	27,50 kg
<b>Max capacity</b>	120 kg

## WARNINGS!

- Check the locking nuts are tightened.
- Observe the maximum flow rates indicated in the data sheets.
- Avoid direct contact with open wounds.
- Not for use in open environments.
- When adjusting the height of the couch and the back, make sure that no one inserts hands, legs or anything into the movement area: **CRUSHING RISK!**
- Move the bed without lifting it from the floor.
- Before moving the bed, unlock the wheels.











## MAINTENANCE AND CLEANING

- Use only original spare parts.
- Periodically check all fixing points.
- To preserve at best, it is recommended to avoid prolonged exposure to sunlight, to contact and deposit in saline and very humid environments.
- Wash the stainless steel surfaces with soapy water and use appropriate disinfectants.
- Rinse with a damp cloth and dry thoroughly.
- Do not spill on the surface cleaners containing chlorine or ammonia, fatty and oily substances.
- Do not use cleaning utensils containing iron. If necessary disinfection only use suitable non-corrosive products.

## CLEANING RULES FOR COATING:

Clean with damp soapy cloth and rinse well with clean water. Do not use solvents, bleaches, synthetic detergents, polishes or aerosol spray.

Attention: Normally synthetic leather light colours should not come in contact with no fixed cloured clothes (such as jeans and similar) not to cause stains and rings that cannot be cleaned up.

	<i>Keep away from sunlight</i>		<i>Medical Device compliant with Regulation (EU) 2017/745</i>		<i>Keep in a cool, dry place</i>
	<i>Product code</i>		<i>Consult instructions for use</i>		<i>Manufacturer</i>
	<i>Date of manufacture</i>		<i>Lot number</i>		<i>Medical Device</i>
	<i>Caution: read instructions (warnings) carefully</i>				

## GIMA WARRANTY TERMS

The Gima 12-month standard B2B warranty applies.