



GIMA

PROFESSIONAL MEDICAL PRODUCTS

1200G ECG 12 CHANNEL WITH MONITOR

REF ECG1200G (33224)



CONTEC MEDICAL SYSTEMS CO., LTD
No. 112 Qinhuang West Street,
Economic & Technical Development Zone,
Qinhuangdao, Hebei Province,
PEOPLE'S REPUBLIC OF CHINA
Made in China

EC REP

Shanghai International Holding Corp. GmbH (Europe)
Eiffestrasse 80, 20537, Hamburg, Germany

CE 0123

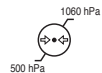

Preface

Please read the User Manual carefully before using this product. The operating procedures specified in this User Manual should be followed strictly. This manual describes in detail the operation steps which must be noted, the procedures which may result in abnormality, and possible damage to the product or users. Refer to following chapters for details. Failed to follow the User Manual may cause measuring abnormality, device damage or personal injury. The manufacturer is NOT responsible for the safety, reliability and performance issues of such results due to user's negligence of this user manual for using, maintenance or storage. The free services and repairs do not cover such faults either.

The content in this user manual complies with real product. For software upgrade and some modifications, the content in this user manual is subject to change without prior notice, and we sincerely apologize for that.

Attentions

Before using this product, the safety and effectiveness described in the following shall be considered:

- Type of protection against electric shock: class I (AC power supply), internal powered equipment (power supplied by battery)
- Degree of protection against electric shock: type CF, defibrillation-proof function applied part
- Working mode: continuous running equipment
- Enclosure protection class: IPX0
- Measurement results shall be described by professional doctor combined with clinical symptoms.
- The using reliability depends on whether the operation guide and maintenance instructions in this user manual is followed.
- Service life: 5 years
- Date of manufacture: see the label
- Contraindications: none

 Warning: To ensure the device safety and effectiveness, please use the company recommended accessories. The maintenance and repair of the device should be done by professional personal specified by the company. It is forbidden to refit the device.

Responsibility of the operator

- The device must be operated by a professionally trained medical staff, and kept by a special person.
- The operator should read the User Manual carefully before use, and strictly follow the operating procedure described in the User Manual.
- The safety requirements have been fully considered in product designing, but the operator can not ignore the observation of the patient and device.
- The operator is responsible for providing the information of product use to the company.

Responsibility of the company

- The company supplies qualified products to user in accordance with enterprise standard.
- The company installs and debugs the equipment and trains the physicians by contract.
- The company performs device repair in warranty period (a year) and maintenance service after warranty period.
- The company responds timely to the user's request.

The user manual is written by Contec Medical Systems Co., Ltd. All rights reserved.

Statement

Our company owns all rights to this unpublished work and intends to maintain it as confidential information. This user manual is used only for reference of operation, maintenance, or repair of our device. No part of this can be disseminated to others. And our company takes no responsibilities for any consequences and liabilities caused by using this user manual for other purposes.

This document contains proprietary information, which is protected by copyright. All rights reserved. Photocopy, reproduction or translation of any part in the manual without our company's written permission is prohibited.

All information contained in this user manual is believed to be correct. Our company shall not be liable for incidental and consequential damages in connection with the furnishing, performance, or use of this material. This user manual may refer to information and protected by copyrights or patents and does not convey any license under the patent rights of our company, nor the rights of others. Our company does not assume any liability for arising out of any infringements of patents or other rights of the third parties.

Our company owns the final explanation right to this user manual, and reserves the right to change the content of this user manual without prior notice, and the rights to change product technology and specification.

Contents

Chapter1 Overview.....	1
1.1 Overview.....	1
1.2 Intended use.....	1
1.3 Main technical specifications.....	1
1.4 Main Characteristics.....	2
1.5 Software overview.....	3
Chapter2 Safety Precautions.....	4
Chapter3 Warranty.....	7
Chapter4 Working Principle and Structural Characteristics.....	8
4.1 Working principle and its block diagram.....	8
4.2 Name of each part and its function.....	9
Chapter 5 Operation Precautions.....	14
5.1 Precautions before use.....	14
5.2 Precautions during operating.....	14
5.3 Precautions after use.....	14
Chapter 6 Preparations before Operation.....	15
6.1 Installation of recording paper.....	15
6.2 Power supply connection.....	16
6.3 Lead cable connection.....	16
6.4 Electrode installation.....	17
Chapter 7 Operation Instructions and Parameter Setting.....	20
7.1 Main Interface.....	20
7.2 Sampling interface.....	21
7.3 Case information input interface.....	24
7.4 Case management.....	25
7.5 Date and time setup.....	28
7.6 System setup.....	28
7.7 Sampling setup.....	30
7.8 Print setup.....	30
7.9 Lead placement.....	32
7.10 About.....	33

Chapter 8 Troubleshooting.....	34
8.1 Auto shutdown.....	34
8.2 AC interference.....	34
8.3 EMG interference.....	34
8.4 Baseline drift.....	35
8.5 Troubleshooting list.....	35
Chapter 9 Maintenance.....	37
9.1 Battery.....	37
9.2 Recording paper.....	38
9.3 Maintenance after use.....	38
9.4 Lead cables and electrodes.....	39
9.5 Silicone rubber roller.....	39
9.6 Cleaning of thermal print head.....	39
9.7 Fuse replacement.....	39
9.8 Disposal of product scrap.....	40
9.9 Others.....	40
Chapter 10 Packing List and Accessories.....	41
10.1 Accompanying accessories.....	41
10.2 Notes.....	41
Appendix I ECG Automated Measurement&Interpretation Guide.....	42
1. Preface.....	42
2. Automated measurement parameters and Automated interpretation items.....	42
3. Algorithm description.....	44
3.5 Interpretations judgment based on parameters.....	50
4. Data sources and data preprocessing.....	54
4.5 Data coverage of verification for automated interpretation.....	56
5. Process and Result of Verification.....	58
5.1 Verification of measurement function.....	58
Appendix II EMC Guidance and Manufacturer Declaration.....	67

Chapter1 Overview

1.1 Overview

This product is a kind of electrocardiograph, which is able to sample 12 leads ECG signals simultaneously and print out the ECG waveform with thermal printing system. Its functions are as follows: recording and displaying ECG waveform in auto/manual mode; measuring ECG waveform parameters automatically, and automatic analysis and diagnosis; prompt for electrode-off and out of paper; optional interface languages(Chinese/English, etc.); built-in lithium battery, powered either by AC or DC; arbitrarily select the rhythm lead to conveniently observe abnormal heart rate; case database management, etc.

1.2 Intended use

This product is suitable for hospital, scientific research, wards, ambulances and carrying out medical consultations. It can be used by medical institutions to record human ECG signals, collect and extract the ECG waveform.

1.3 Main technical specifications

1.3.1 Environment conditions

Operation:

- a). Environment temperature: 5°C~40°C
- b). Relative humidity: 25%~95%(no condensation)
- c). Atmospheric pressure: 700 hPa~1060 hPa
- d). Power supply:

Voltage: 100-240 V~

Frequency: 50 Hz, 60 Hz

Input power: ≤150 VA

Battery: 14.8 V, 3500 mAh rechargeable lithium battery

Transportation and Storage:

- a). Environment temperature: -20 °C~+55 °C
- b). Relative humidity: ≤95%
- c). Atmospheric pressure: 500 hPa~1060 hPa

1.3.2 Input way: Floating and defibrillation protection

1.3.3 Lead: Standard 12 leads

1.3.4 Patient leakage current: <10μA

1.3.5 Input impedance: ≥2.5 MΩ

1.3.6 Frequency response:

Test	Input frequency and waveform	Relative output response
1.0	0.67Hz~40Hz, Sine wave	±10% ^a
0.5	40Hz~100Hz, Sine wave	+10 %, -30 % ^a
0.25	100Hz~150Hz, Sine wave	+10 %, -30 % ^a
0.5	150 Hz ~ 500 Hz, Sine wave	+10 %, -100 % ^a
1.5	≤1Hz,200ms, Triangle wave	+0 %, -10 % ^b

^a relative to 10Hz ^b relative to 200 ms

1.3.7 Time constant: $\geq 3.2s$

1.3.8 CMRR: $>105\text{ dB}$

1.3.9 Filter: AC Filter(50Hz/60 Hz), EMG Filter(25 Hz/35 Hz (-3 dB)), DFT Filter

1.3.10 Recording way: Thermal printing system

1.3.11 Specification of recording paper: 210 mm(W) \times 20 mm(L) high-speed thermal paper

1.3.12 Time base selection(paper speed):

12.5 mm/s, 25 mm/s, 50 mm/s, error: $\pm 5\%$

1.3.13 Gain control(sensitivity): 5, 10, 20 mm/mV, accuracy is $\pm 2\%$;

Standard sensitivity: $10\text{ mm/mV} \pm 0.2\text{ mm/mV}$

1.3.14 Auto record: record setup according to auto record format and mode, automatically change leads, automatically measure and analyze.

1.3.15 Rhythm record: record setup according to rhythm record format and mode, automatically measure and analyze.

1.3.16 Manual record: record according to manual record format.

1.3.17 Measurement parameters: HR, P-R interval, P Duration, QRS Duration, T Duration, Q-T interval, Q-Tc, P Axis, QRS Axis, T Axis, R(V5) amplitude, S(V1) amplitude, R(V5)+S(V1) amplitude

1.3.18 Product safety type: Class I type CF defibrillation-proof function applied part

1.3.19 Polarization resistance voltage: $\pm 610\text{ mV}$

1.3.20 Noise level: $\leq 12\text{ }\mu\text{Vp-p}$

1.3.21 ECG signal input sampling frequency: 32 kHz

1.3.22 Waveform data processing sampling frequency: 1 kHz

1.3.23 Sampling precision: 24-bit

1.3.24 The minimum detection signal: 10 Hz, 20 μV (peak-peak value) deflected sinusoidal signal can be detected

1.3.25 Pacing detection channel: standard II

1.3.26 Accuracy of input signal: The overall system error, $\pm 5\%$.

1.3.27 Amplitude quantization: $\leq 5\mu\text{V/LSB}$

1.3.28 Interchannel time deviation: $<100\text{ }\mu\text{s}$

1.3.29 Fuse specification: 2pcs $\phi 5 \times 20\text{mm}$ AC delay insurance: T1.6AL250V

1.3.30 Dimension: 340 mm(L) \times 320 mm(W) \times 85mm(H)

1.3.31 Net Weight: 3.2 kg

1.4 Main Characteristics

1.4.1 Display with 800*600 dots, 8" high-resolution color LCD, operate either by touch screen or function buttons, which is convenient and quick.

1.4.2 Sync collection for 12-lead ECG, use digital signal processing technology to conduct AC filter, baseline filter and EMG filter on ECG signals, in order to get high-quality ECGs.

1.4.3 Display of 3/6/12-lead ECG on one screen, and print mode, sensitivity, paper speed, filter state and other information, which facilitates comparative diagnosis.

1.4.4 The device can be powered either by AC or DC(can adapt to 50/60Hz AC frequency), with built-in rechargeable lithium battery and charging circuit, perfect battery overcurrent and

overvoltage protection circuit.

1.4.5 Multiple print mode and format, including, automatic 12×1, 6×2+1(rhythm lead), 6×2, 3×4+2 (rhythm lead), rhythm 12, rhythm 10, rhythm 8, rhythm 6 and manual. Trend graph and histogram of RR interval can be printed. Printed waveform length is adjustable. With timed print function to satisfy various application requirements.

1.4.6 Rhythm leads can be arbitrarily selected to facilitate the observation of abnormal heart rate.

1.4.7 Clinical information such as patient's name, gender, age, sampling mode and department can be input.

1.4.8 The built-in large-capacity memory, making it easy for doctor to review medical records and statistical information.

1.4.9 Multi-language (Chinese, English, Turkish, Portuguese, German, Russian, Kazakhstan, etc.) interface and report.

1.5 Software overview

Name of software: ECG1200G embedded software

Software specification: none

Software version: V1.6.1

Version naming rules: V<major version number>.<minor version number>.<revision version number>

The version of the software can be obtained in "About".

Involved algorithm:

Name: ECG algorithm

Type: mature algorithm

Use: to convert ECG signals of human body into intuitive waveform images and then analyzing.

Clinical function: Electrocardiogram is an important method for clinical diagnosis of cardiovascular disease. How to use computer to quickly, automatically and accurately analyze ECG has been a hot topic for scholars at home and abroad. The ECG algorithm is the key to the analysis and diagnosis of ECG signals, and its accuracy and reliability determine the effectiveness of diagnosis and treatment of patients with heart disease.

Chapter2 Safety Precautions

2.1 Ensure that the device is placed on a flat level worktable. Avoid strong vibration or impact when moving it.

2.2 When working with AC power, the power cord must be 3-core, the frequency and voltage value of the AC power source must match the identification on the manual and have sufficient capacity. When the provided three-core power cord cannot be used, please use the built-in DC power supply or replace the three-core power cord that meets the standard requirements.

2.3 A perfect power supply system and grounding are necessary in the room.

 Warning: To avoid the risk of electric shock, the device must be connected a power supply with protective grounding.

2.4 If there are any questions for the integrality of protective grounding cable or the reliability of protective grounding cable connection can not be guaranteed, the device must be run with built-in DC power supply.

2.5 The safety requirements have been fully considered in product designing, but the operator can not ignore the observation of the patient and device. Cut off the power or take off the electrode when necessary to ensure patient's safety.

2.6 Please turn off the device and unplug the power cord before replacing the fuse or cleaning and disinfection. Don't rub the screen with sharp materials.

2.7 Keep the device from water, don't use or store it in places with high air pressure, humidity or temperature over the standard, bad ventilation, or too much dust.

2.8 Do not use the device in the place with flammable anesthetic gases or other flammable chemicals, otherwise there is a danger of explosion or fire.

2.9 Do not use the device in medical hyperbaric oxygen chamber, otherwise there is a danger of explosion or fire.

2.10 This device is not intended to act directly on the human heart. If this device is used with cardiac defibrillator or other electric stimulating devices at the same time, single-use electrodes and ECG lead cables with defibrillation-proof function should be selected. It is better not to use this device with other electric stimulating devices at the same time. If it is necessary, there must be professional technician guiding on the scene, and the selected accessories should be designated by our company.

 Warning: Do not operate the instrument on parts of human body with wounds, and do not perform measurements on parts with wounds on the surface.

2.11 When the electrocardiograph is used together with a high-frequency electrosurgical knife, the ECG electrode should be kept away from the contact of the electrosurgical knife to prevent burns and burning of the electrode wires caused by high-frequency sparks.

2.12 When the electrocardiograph is used together with a defibrillator, the operator should avoid contact with the patient or the sickbed. The defibrillation electrode should not directly touch the ECG electrode to prevent sparks from burning the device and the patient.

2.13 Please do not use the electrocardiograph in the environment that is interfered by high-power device such as high-voltage cables, X-rays, ultrasonic machines and electrizer, keep the device away from emission sources such as mobile phones.

2.14 If other equipment is connected with this ECG device, it must be a Class I device that complies with IEC60601-1. Because the total leakage current may hurt patient, the monitoring of leakage current is carried out and taken charge by the connected equipment.

2.15 Notes related to EMC

The device complies with the safety standards for medical electrical equipment or system electromagnetic compatibility in IEC60601-1-2. Electromagnetic environments exceeding the IEC60601-1-2 standard may cause harmful interference to the device or prevent the device from performing its intended function or degrade its performance. Therefore, if there is a phenomenon that does not match its function during use, be sure to confirm and eliminate adverse effects before continuing to use it. Corresponding precautions for this situation are given in this manual.

- The device or system should not be used near or stacked with other devices. If it must be used near or stacked with other devices, it should be observed and verified that the device is working normally under the configuration it is using.
- Use of accessories, transducers, and cables other than those specified by the manufacturer of the device or system as spare parts for internal components may result in increased emissions of the device or system and reduced immunity.
- Effect from radiated electromagnetic waves:

The use of a mobile phone may affect the operation of the device. When installing medical electrical equipment, be sure to remind people around the device to turn off mobile phones and small radios.

- Effect from shock and conduction electromagnetic waves:

High frequency noise from other equipment can enter the device through the AC socket. Please identify the source of noise, if possible, stop using the equipment. If the equipment can not be deactivated, use noise cancellation equipment or take other measures to reduce the impact.

- Effect from static electricity:

Static electricity in a dry environment(indoor) may affect the operation of the device, especially in winter. Before using the device, humidify the indoor air or discharge the static electricity from the cable and operator.

- Effect from thunder and lightning:

If there is thunder and lightning nearby, it may cause a voltage surge in the device. If you are concerned about danger, disconnect the AC power and use the internal power supply.

2.16 Notes concerning ECG waveform measurement and analysis

2.16.1 The identification of P wave and Q wave is not always reliable with intensive EMG or AC interference. Neither are the ST segment and T wave with baseline drift.

2.16.2 Winding and unclear end position of S wave and T wave may cause error in measurement.

2.16.3 When R wave is uninspected caused by some leads off or QRS wave low voltage, the heart rate measurement may deviate greatly from the correct.

2.16.4 In case of QRS low voltage, ECG axis calculation and border-point identify of QRS wave are not always reliable.

2.16.5 Occasionally, frequent ventricular premature complexes may be identified as dominant beat.

2.16.6 Merging of versatile arrhythmia may result in unreliable measurement because of the difficulty in distinguishing P wave in such situation.

2.16.7 The device has an automatic analysis function that automatically analyzes the obtained ECG waveform without reflecting all the patient's status. The results of the analysis may sometimes not comply with the doctor's diagnosis. Therefore, the final conclusion needs to be comprehensively analyzed by doctors in combination with analysis results, patient clinical characterization and other test results.

Chapter3 Warranty

3.1 In normal use, under strict observance of user manual and operation notes, in case of failure, please contact with our customer service department. Our company has the sales record and customer archives for each device. The customer has one year free warranty service from the date of shipping according to the following conditions. To supply all-around and quick maintenance service for you, please mail the maintenance card to us in time.

3.2 Our company may adopt such ways as guidance, express to company or door-to-door service, etc. to carry out warranty promise.

3.3 Even in warranty period, the following repairs are charged.

3.3.1 Faults or injuries caused by misuse that not according to user manual and operation notes.

3.3.2 Faults or injuries caused by dropping accidentally after purchase.

3.3.3 Faults or injuries caused by repair, reconstruction, decomposition, etc. not by our company.

3.3.4 Faults or injuries caused by improper storage or force majeure after purchase.

3.3.5 Faults or injuries caused by using improper thermal recording paper.

3.4 The warranty period for accessories and fray parts is half a year. Power cable, recording paper, operation manual and packing material are excluded.

3.5 Our company is not responsible for the faults of other connected devices caused by the faults of this device directly or indirectly.

3.6 The warranty will be canceled if we find the protection label has been destroyed.

3.7 For charged maintenance beyond warranty period, our company advises to continue using "Maintenance contract regulation". Please refer to our customer service department for details.

Chapter4 Working Principle and Structural Characteristics

4.1 Working principle and its block diagram

4.1.1 The power supply unit

(1) Principle of power supply

The switching power supply provides +24V working voltage for the thermal print head, provides constant voltage current limiting charging for the rechargeable lithium battery in the device through the DC-DC circuit, and generates +5V and +12V voltage through the power conversion to supply power to the corresponding modules. At the same time, the lithium battery in the device can independently satisfy working requirements of each module in the device through the buck-boost circuit.

(2) Principle block diagram is shown in Figure4-1.

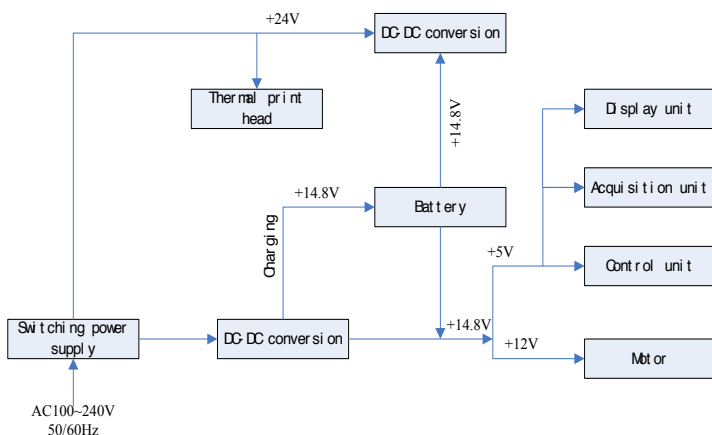

Figure4-1 Block diagram of power principle

⚠️ Note: The principle block diagram and component list are only available to service stations or maintenance personnel designated by our company.

4.1.2 Signal acquisition unit

The signal acquisition unit uses a floating setting, which is a signal acquisition and processing system, including analog circuit part and A/D conversion (with sampling accuracy of 24 bits) and data processing part. The analog circuit consists of signal following, amplification, anti-aliasing low-pass filtering, lead-off detection and overload detection. CPU system is responsible for coordinating the work of each circuit such as the A/D converter, the lead-off detection circuit and the overload detection circuit, in order to achieve signal acquisition, processing, and lead-off detection. Control information and A/D conversion and data acquisition between the floating circuit and the solid circuit are transmitted through the optoelectronic

coupler.

4.1.3 Control unit

(1) Principle of control unit

The control system consists of printing system, button system, liquid crystal display system, and signal acquisition system. The ECG signal sent from the signal acquisition system through the high-speed optoelectronic coupler is received by the CPU system, after digital filtering, gain adjustment and motor drive, it is sent to the printing system to print the ECG waveform. After the printing is completed, the CPU system processes waveform measurement and analysis. The CPU system also receives an interrupt signal and button code from the button system to complete the interrupt processing. In addition, the lead-off signal, paper out detection, battery voltage management, and automatic power-off are also managed by the CPU system. The liquid crystal controller receives data and commands from the CPU system to complete the display of the control state of the device.

(2) Principle block diagram is shown in Figure4-2.

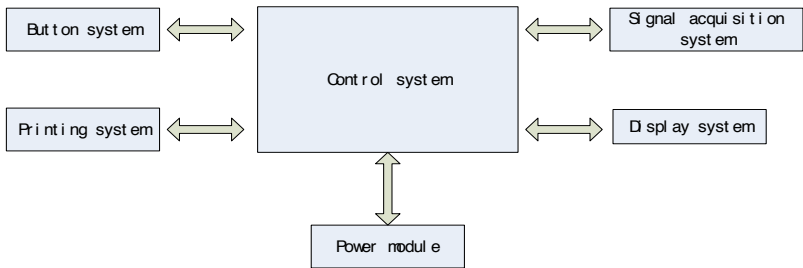

Figure 4-2 Block diagram of control unit

4.2 Name of each part and its function

4.2.1 Front view

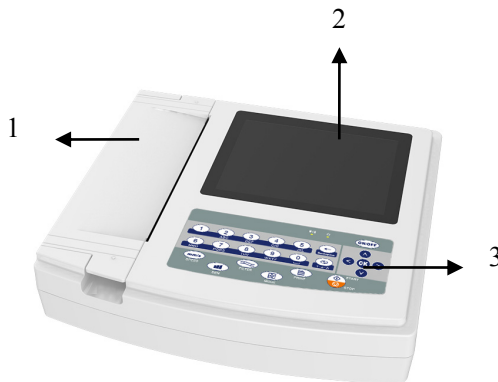

Figure 4-3 Front view

1. Paper compartment cover

Keep the paper compartment closed, hold the printing paper

2. Display screen

Display patient's ECG and related information

3. Button area

Control the operations of the device, and enter information.

⚠ Note

- **Do not put heavy objects on the screen or hit against it, otherwise the screen will be damaged.**
- **If the device is not in use, cover it to prevent liquid spills on the screen.**
- **Do not use sharp stuff to operate the buttons, otherwise it may cause permanent damage to the buttons.**

4.2.2 Side view

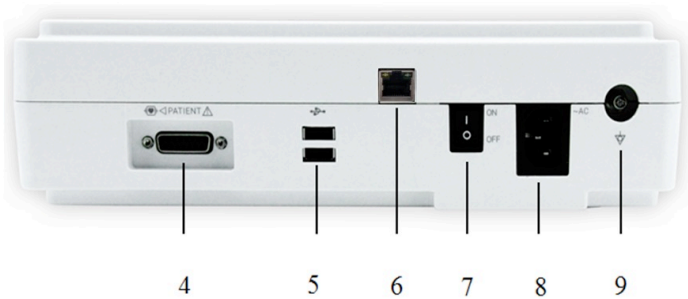

Figure 4-4 Side view

4. Lead cable interface

Connect with lead cables.

5. USB interface

Communicate with the computer. The ECG data can be transmitted to a computer, by using the computer, many functions can be achieved, such as archiving, managing, and analyzing ECG data, which facilitates clinical research, organization teaching and training.

6. Network interface

Connect with the LAN, then perform case analysis and remote control by expert in the LAN.

7. Mains power switch

A control button connecting with AC power.

8. Input socket

Connect with the AC power cord.

9. Equipotential terminal

Connect with the potential equalization conductor.



Figure 4-5 Bottom view

10. Battery compartment

Built-in rechargeable lithium battery.

11. Fuse

Built-in fuse tube, T1.6A L250V. It can avoid the damage to human body caused by large voltage and large current generated by grid pollution.

⚠️ Note

Lead cables must be disconnected from patient before connecting with a computer via the USB interface.

Operator must not touch the USB interface and patient at the same time.

4.2.3 Buttons

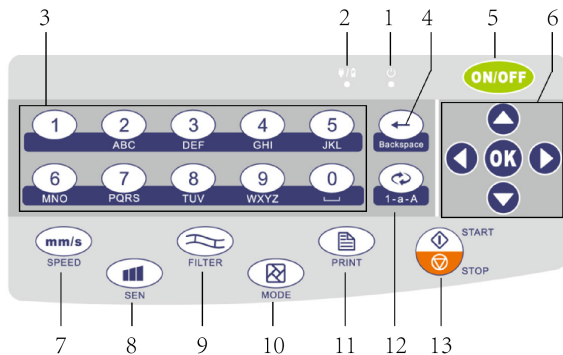

Figure 4-6 Schematic diagram of buttons

1. Startup indicator

It lights in green after turning on the device.

2. Power status indicator

Green indicates that the AC power supply is used. At this time, there is no battery in the device or the battery is full. Red and green two colors indicate that the battery is being charged.

3. Number buttons

Input patient's information, hospital name, bed number and other information, both Chinese and

English are supported.

4. Backspace

Change entered information, long pressing it could clear the title.

5. ON/OFF

When the device is turned on, short press this button, it will prompt whether to shut down the device, long press this button to turn off the device.

6. Direction buttons

Including up, down, left, right and OK buttons, quick and convenient

7. SPEED

Change the ECG recording speed

8. SEN

Adjust the sensitivity manually.

9. FILTER

Set the filter mode.

10. MODE

When the device in sampling interface, use MODE button to select the print mode.

11. PRINT

Print the sampled ECG waveform or end the printing.





12. Switch button of input method



















Under the inputting state, use this button to switch between numbers, lowercase, capital and symbols.

13. Setting button of acquisition system

Collect ECG waveform and set the display mode.

4.2.4 Symbols

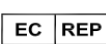
	Alternating current
OFF	Alternating current--OFF
ON	Alternating current--ON
	Equipotential point, the equipotential point of this device is combined with the protective grounding.
	Caution! Refer to the accompanying document.
	Type CF equipment, with defibrillation-proof function
	USB interface
◀ PATIENT	Lead cable socket
FUSE T1.6AL250V Φ5×20	Fuse specification
SN	Serial number

	Manufacturer
	Date of manufacture
	Batch code
	Latex free
	Atmospheric pressure limitation
	Temperature limitation
	Humidity limitation
	For indoor use only
	Polarity of d.c. power connector
	Waste disposal symbol. This symbol indicates that electrical and electronic equipment waste cannot be disposed of as unsorted municipal waste and must be recycled separately.
	This way up
	Fragile, handle with care
	Keep away from rain
	Stacking limit by number
	Refer to instruction manual/booklet
	This item is compliant with Medical Device Directive 93/42/EEC of June 14,1993,a directive of the European Economic Community.
	Catalogue number
	Authorized representative in the European Community
	General warning sign NOTE : Background col our: yellow Triangular band: Black

Chapter 5 Operation Precautions

5.1 Precautions before use

- 5.1.1 For safe and effective use, please read the user manual carefully before operation.
- 5.1.2 Check to ensure that the device is in good condition.
- 5.1.3 The device shall be placed on a flat surface, and moves gently to avoid strong vibration or shock.
- 5.1.4 Check to ensure that the lead cables are correctly connected, and the device grounding is correct.
- 5.1.5 The AC frequency and voltage should comply with the requirements, and enough current capacity should be guaranteed.
- 5.1.6 When using the battery for power supply, check to ensure that the battery voltage and battery status are in good condition, and the battery has enough power.
- 5.1.7 When the device is used together with other equipment, all devices and equipment should be equipotential grounded in order to protect the user and operator.
- 5.1.8 Install the device where easily grounded in the room. Do not allow the patient and patient-connected lead cables and electrodes to come into contact with other conductor parts, including the earth or a hospital bed.
- 5.1.9 Clean the lead cable with neutral solvent. Do not use alcohol-based cleaners or germicides.
- 5.1.10 Ensure that the device is running within the normal ambient temperature range of 5°C to 40°C. If the device is stored at a higher or lower temperature, leave it in the operating environment for approximately 10 minutes before use in order to ensure the normal work.

5.2 Precautions during operating

- 5.2.1 The printing can be started after the ECG waveform is stable.
- 5.2.2 During using, the doctor should observe the patient carefully and cannot leave the operating site. If necessary, turn off the power or remove the electrode to ensure patient safety.
- 5.2.3 The patient and the device can only be connected via lead cables through the electrodes, in order to avoid patient touches other parts of device or conductors.
- 5.2.4 Patient can not move during operating.
- 5.2.5 Maintenance or repair to the device or accessory is not allowed during using.

5.3 Precautions after use

- 5.3.1 Set the states of all functions to initial states.
- 5.3.2 Cut off the power, gently remove the electrodes and limb clips, then remove the lead cables, do not pull with force.
- 5.3.3 Clean the device and all accessories, and store them for the next use.

Chapter 6 Preparations before Operation

6.1 Installation of recording paper

6.1.1 The device adopts high-speed recording paper, its specification is 210 mm(W)×20 m(L).

6.1.2 The installation method of recording paper is described as below:

1. As shown in Figure 6-1, use both hands to lift both sides of the paper compartment cover at the same time to open it. Take out the roller, insert it into the roll paper as shown in the figure. The paper side with grids should be faced downwards, and then install it to proper position in the paper compartment.



Figure 6-1 Installation of recording paper

2. Pull out the recording paper from the slot of the paper compartment cover, and close the cover.

Note

- **When opening the paper compartment cover, it is not allowed to open one side separately, otherwise the operation of the device will be affected.**
- **The recording paper should be aligned with the slot of the paper compartment cover. It is recommended to leave 2cm paper outside.**

6.1.3 If the recording paper runs out during recording, the device will stop printing automatically, and the screen will display a prompt of lack of paper, as shown in Figure 6-2.

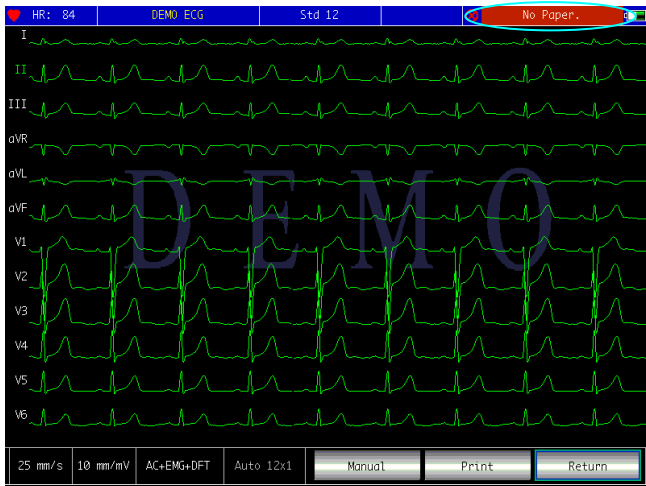

Figure 6-2 Lack of paper prompt

6.2 Power supply connection

6.2.1 AC

Insert one end of the provided three-core power cord into the device's input socket, and insert the other end into a three-core power socket that meets the requirements. Ensure that the connection is secure and reliable, and the device is automatically grounded.

When the device is used in conjunction with other medical equipment, use the supplied potential equalization wire to connect the equipotential terminal of the device to the equipotential terminal of the connected equipment to prevent leakage current and protect the device.

6.2.2 Battery

The device has a built-in rechargeable lithium battery, which does not need to be re-installed by user. Check the battery's power and status before use.

⚠️ Note: Connect one end of the potential equalization wire to the equipotential terminal of the device, and connect the other end to the ground to enhance the reliability of the grounding. Do not use other pipes as ground wire, otherwise, the patient may be in danger of electric shock.

6.3 Lead cable connection

Connect the lead cable to the lead cable interface on the device, and fasten it to the device with the fixing knobs at both sides of the lead cable in order to prevent bad connection and affecting the detection.

⚠️ Note: The lead cable interface can not be used for other purposes except as the input interface of ECG signals.

6.4 Electrode installation

Proper installation of the electrodes is an important part of accurately recording the electrocardiogram. Make sure the electrodes are in good contact. Old and new electrodes or reusable electrodes and disposable electrodes cannot be used at the same time. If different types of electrodes are used together, it will seriously affect the ECG recording. The electrode or lead plug must not touch other object surfaces or conductors, such as metal beds. Please replace them all when updating the electrodes.

6.4.1 Chest electrodes

As shown in Figure 6-3:

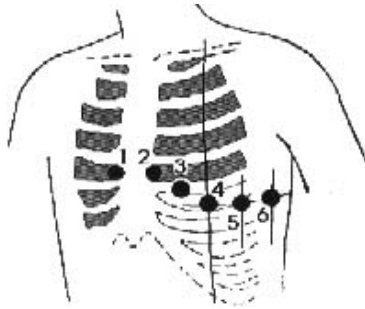

Figure 6-3 Installation of chest electrode

The chest electrodes should be installed to the following parts:

C1 (V1) : the fourth intercostal space at the right sternal margin

C2 (V2) : the fourth intercostal space at the left sternal margin

C3 (V3) : between C2 and C4

C4 (V4) : the intersection between midclavicular line and the fifth intercostal space

C5 (V5) : left anterior axillary line on the same plane as C4

C6 (V6) : left midaxillary line on the same plane as C4

Clean the chest skin where the electrodes to be installed with alcohol, and apply some conductive pastes to these skin (about 25 mm-diameter range) and the edge of the chest electrode suction cup. Squeeze the suction ball to install the chest electrode at the positions of C1-C6.

⚠️Note: The conductive paste coating should be separated from each other, and the chest electrodes should not touch each other to avoid short circuit.

⚠️Note: Please use qualified conductive paste to avoid damaging the skin.

6.4.2 Limb electrodes

The limb electrodes should be placed on the soft skin of both hands and feet. Before connecting, clean the skin of the electrode installation area with alcohol, and then apply a small amount of conductive paste on the cleaned skin. The electrode connection of the limbs is shown in Figure 6-4.

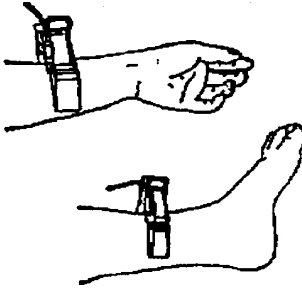

Figure 6-4 Installation of limb electrodes

6.4.3 Colors of lead cables

As shown in Table 6-1:

Table 6-1 Colors of lead cables

Electrode position	European standard		American standard	
	Mark	Color	Mark	Color
Right arm	R	Red	RA	White
Left arm	L	Yellow	LA	Black
Left leg	F	Green	LL	Red
Right leg	N/RF	Black	RL	Green
Chest 1	C1	Red	V1	Red
Chest 2	C2	Yellow	V2	Yellow
Chest 3	C3	Green	V3	Green
Chest 4	C4	Brown	V4	Blue
Chest 5	C5	Black	V5	Orange
Chest 6	C6	Purple	V6	Purple

⚠ Note

- It is recommended to install the lead cables after turning off the device.
- Apply appropriate amount of conductive paste on the electrode when installing the electrode.
- If the ECG waveform does not appear for a long time, check if the electrode is in good contact with the skin.

6.4.4 Lead method and system

As shown in Figure 6-5:

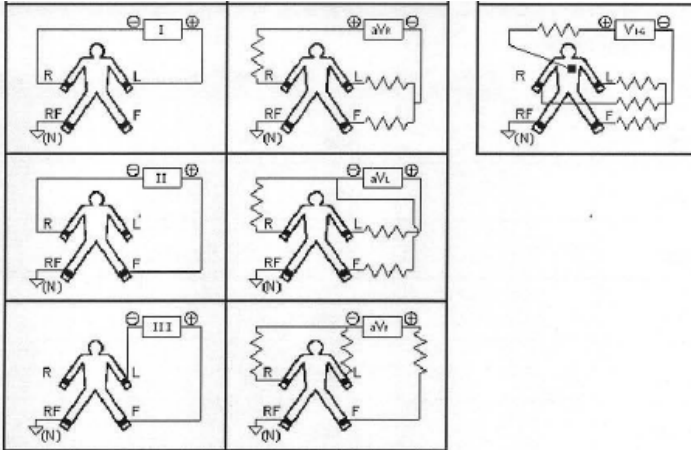

Figure 6-5 Lead system

6.4.5 Lead-off and overload indication

The device can check the connection status of the lead at any time. If lead-off or overload is detected, the screen will display corresponding lead code on the top left corner, as shown in Figure 7-2.

Note

- In the lead-off prompt area, red font represents lead-off, yellow font represent overload.
- When the connection between lead cable and patient/the device is not reliable, and the ECG signal can not correctly transmitted, the device displays lead-off.

Chapter 7 Operation Instructions and Parameter Setting

7.1 Main Interface

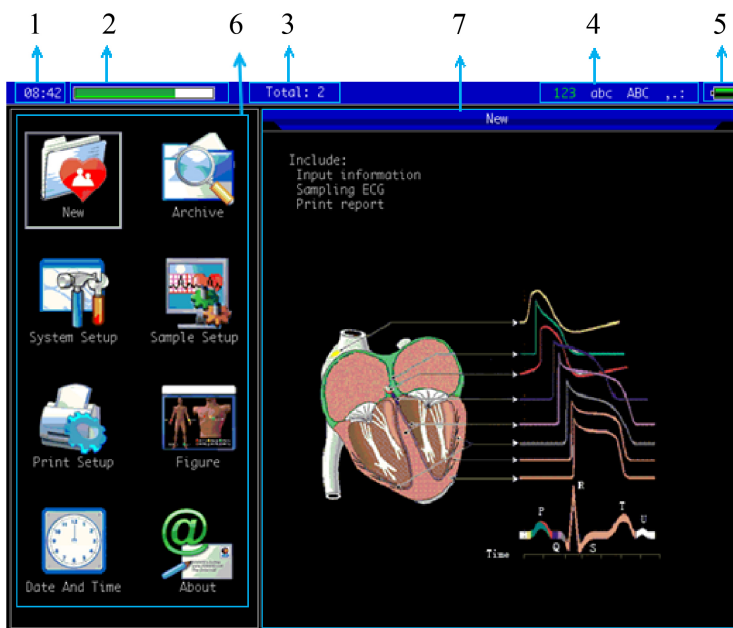

Figure 7-1

Status bar

1. Time



System time can be set in **Date And Time**, so the detail time of ECG recording can be noted.

2. Memory usage

It directly shows the capacity of memory space according to actual usage. The green part represents the memory usage, the white part represents the remaining memory space.

3. Total number of cases stored in memory

4. Input method indication



Current input method is marked by green color. Use **1-a-A** button to switch input methods.

5. Battery level (refer to 9.1)

Menus

6.Functional panel:



to enter the sampling interface to collect and display waveform, and print report.



to enter the case management interface, in this interface, user can query, modify, delete and export case information or review the case to view and print the diagnosis report.



to view the placement of leads



to set time and date



to perform system setting







to perform sampling setting



to set the print mode, print style and print content, etc.



to view software version and other information



Quick switch: use the     buttons on the keyboard to switch between each functional module, after selecting, press  button to enter its setting.

Quick setup: Click the functional module on the screen to quickly set the corresponding function.

7.Friendly tips.

7.2 Sampling interface



Click  on the main interface or press the  button to enter the sampling interface.

⚠️Note: There is input time of cases in the system setting, therefore, in default, case information should be input before sampling. (refer to 7.3 for details)

The sampling interface provides several lead display modes, including 1-lead, 3-lead, 6-lead and 12-lead. The following figure uses 12-lead as an example:

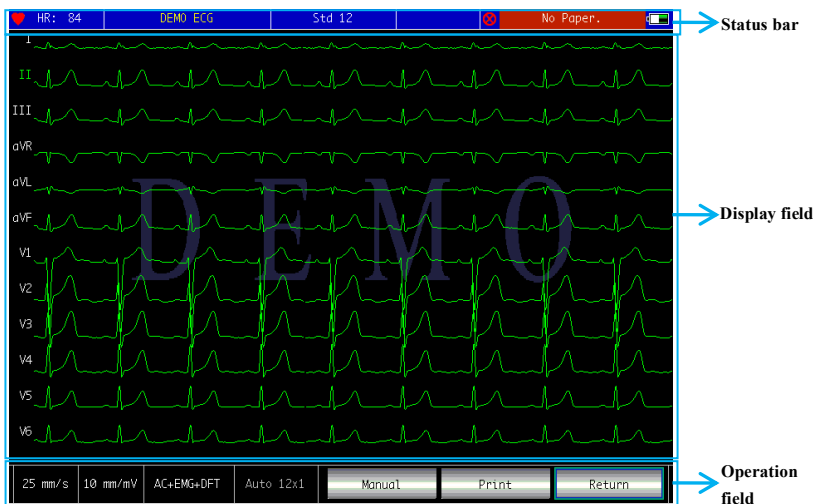

Figure 7-2

Status bar

1. HR: current sampled heart rate value
2. Lead-off and overload: In demo mode, it displays “DEMO ECG”. In sampling mode, it displays the detected lead status. A red lead icon represents lead-off. A yellow lead icon represents overload.
3. Std 12: It shows the sampling method. Before sampling, the sampling method can be set in patient information input dialog box, settings include standard 12-lead, additional 6-lead, and standard 12-lead+additional 6-lead.
4. System status indication:

Display content	Explanation
Process...	It is printing.
Waiting...	It is finishing printing.
No Paper.	Lack of paper, user should restart printing after loading paper.
Print Timeout	Communication failure between this system and printing sub-system.
ECG Timeout	Communication failure between this system and sampling sub-system.
Low Power!	Low power, it cannot start printing.
No USB device	No external printer connected, user should restart printing after connected to the external printer.
Gather Time Less	The sampling time is not enough, the print shall be started after reaching the required time period.

Display field

The screen displays sampled 12-lead ECG waveform, by double clicking the waveform, you can switch between 1-lead, 3-lead, 6-lead and 12-lead.

Operation field

Control the print display mode of the device through corresponding operation settings.

1. Speed: use the  button to switch the speed between 5 mm/s, 6.25 mm/s, 10 mm/s, 12.5 mm/s, 25 mm/s and 50 mm/s.

2. Gain (sensitivity): use the  button to switch the gain between 2.5 mm/mV, 5 mm/mV, 10 mm/mV, 20 mm/mV and 40 mm/mV. The overall gain (sensitivity) can be checked by calibration function.

3. Filter: use the  button to switch the filter between NONE, AC, EMG, AC+EMG, DFT, AC+DFT, EMG+DFT and AC+EMG+DFT.

In which:	AC	AC filter
	EMG	EMG filter
	DFT	Baseline filter

4. Print mode: in print setup, when the data type is set to “After Print”, use the  button to switch the print mode between Manual, Auto 12×1, Auto 6×2+1, Auto 6×2+1_H, Auto 6×2, Auto 6×2_H, Auto 3×4+1, Auto 3×4+2, Auto 1×12, Rhythm 12, Rhythm 10, Rhythm 8 and Rhythm 6.

5. Print/End print: use the  button to start or end the printing operation.

1)Auto mode: After starting to print, the system automatically prints and stores the real-time 12-lead ECG waveform. The length is determined by the relevant settings in the print setup. Based on the settings, the automatic analysis data and conclusions are printed, and the system automatically ends printing.

2)Manual mode: After starting to print, user need to switch the lead to print the waveform of different leads, that is, the ECG printed in the manual mode is asynchronous, and the data is not saved. User need to press the PRINT button again when the print needs to be terminated.

3)If lead-off occurs during sampling process, the printed waveform will be marked with “*”.

4)If lead overload occurs during sampling process, the printed waveform will be marked with “+”.

6. During sampling process, press the PRINT button and wait until the printing is completed, it will pop up a dialog box, which includes “Delete check box”, “Review”, “OK” and prompts (If lead-off or overload occurs during sampling process, there will be a prompt in this dialog box). Clicking “Review” could enter the case management to view sampled cases; Select the delete check box and click “OK” to delete the case.

7. End sampling: After the device starts sampling, use the  button to end the sampling,

and back to the main interface.

7.3 Case information input interface

The case information input dialog box is shown as below:

The screenshot shows a dialog box with a blue title bar containing the text "[2020-03-04 08:55:10]". The dialog contains several input fields and buttons. The fields are: Name* (text box), Operator (text box with 'doctor'), Sex (dropdown menu), Age (text box), SampleMode (dropdown menu with 'Std 12'), Section* (text box with 'ECG'), RoomID (text box), BedID (text box), ID (text box), Source (dropdown menu with 'Emergency'), and checkboxes for Emergency and Pace. At the bottom, there are three buttons: Get, Start, and Cancel.

Figure 7-3

Select “Get” to obtain the latest 10 pieces of patient information. For the same patient information, selecting it could add to the edit box. Custom content can be set according to your needs.

“*” represents required content, it can be set after inputting the password in “Servicing” under the System Setup (initial password is 888888).

After selecting a edit box, pressing  button could pop up a soft keyboard shown as below. Click “CN” or “EN” to switch between Chinese and English. Clicking “Caps” can switch between numbers, lowercase letters, capital letters and symbols. “Space” is the space key, press it to enter a space; “Backspace” is the backspace key, press it to delete the last character entered. Click “OK” to confirm the entry and exit the interface.

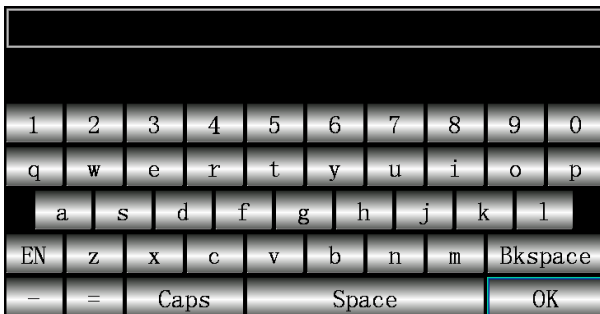

Figure 7-4

The keyboard may have input restrictions according to the limitation of content. The restricted keys will be grayed out and unavailable, as shown below:

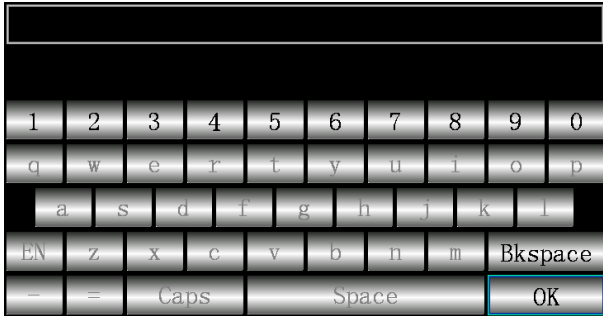





Figure 7-5

In addition, you can use the number buttons on the control panel for editing, and press  button to switch between numbers, lowercase letters, capital letters and symbols. Press  button to delete the last character entered. According to the limitation of the content, the selected input method is displayed in green when switching input method, and the restricted input method is grayed out and unavailable.

7.4 Case management



In the main interface, click  to enter the case management interface, as shown below:

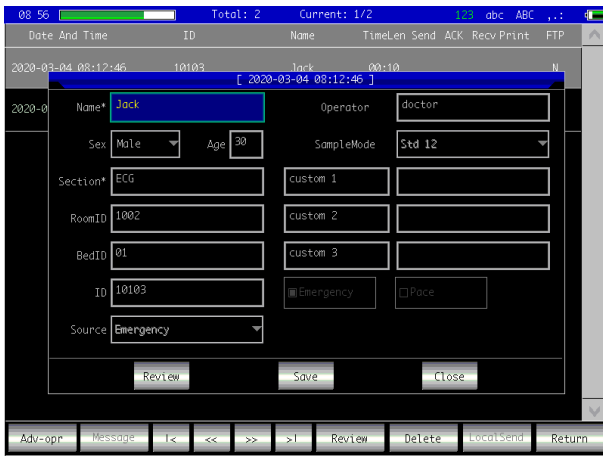





Figure 7-6

The above interface shows all medical records stored in the device. User can search

necessary cases by the query function in the interface (refer to 7.4.1), modify or delete case information by edit function, and review stored case information (refer to 7.4.2).

Click  to jump to the first page of case list.

Click  to jump to the last page of case list.

Click  to jump to the previous page.

Click  to jump to the next page.

In the operation field, “Adv-opr” contains menus of “list ALL” “Query” “Export ECG” and “Return”.

“Export ECG”: export the cases in the device to a U-disk via the USB interface. Export path can be self-defined (symbols such as “\ / : ? < > |” are excluded), the type of files is shown as below:

- 1.JPEG, BMP: the format of report.
- 2.aECG: case data that conform to the HL7 standard
- 3.DAT: case data, self-defined format

“Query”: see 7.4.1

7.4.1 Query

Click “Query” in the “Adv-opr” setting to enter the query interface shown below. Input query conditions and click “Select” to obtain expected results. After clicking “Clear”, the system will clear all query conditions that entered.

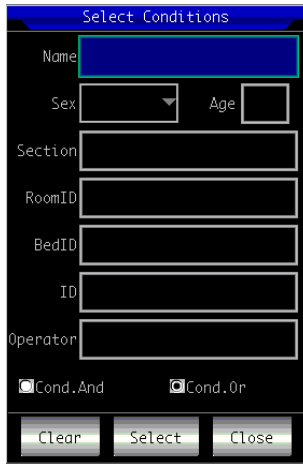

Figure 7-7

“Cond.And” and “Cond.Or” indicate the matching mode of the query conditions. You can choose one of the two. If you select “Cond.And”, the displayed query results will satisfy all the input conditions at the same time; if you select “Cond.Or”, the displayed query results only need to meet any of the conditions entered.

Suggestion: When there are many cases, it would be better to input accurate query conditions and choose “Cond.And” to quickly find the case.

7.4.2 Review

In the case management interface, select a case to be reviewed, click “Review” to enter the following dialog box, which displays the case information. User is allowed to modify patient information, after clicking “Save”, the information will be changed. Please note that the modification is irreversible.

The screenshot shows a dialog box with a title bar containing the date and time: [2020-03-04 08:12:46]. The form contains the following fields and controls:

- Name*: Jack
- Operator: doctor
- Sex: Male (dropdown)
- Age: 30
- SampleMode: Std 12 (dropdown)
- Section*: ECG
- RoomID: 1002
- BedID: 01
- ID: 10103
- Source: Emergency (dropdown)
- Buttons: custom 1, custom 2, custom 3, Emergency (checkbox), Pace (checkbox)
- Bottom buttons: Review, Save, Close

Figure 7-8

Make sure the input information is correct, click “Review” to enter the review interface, which is similar with the sampling interface

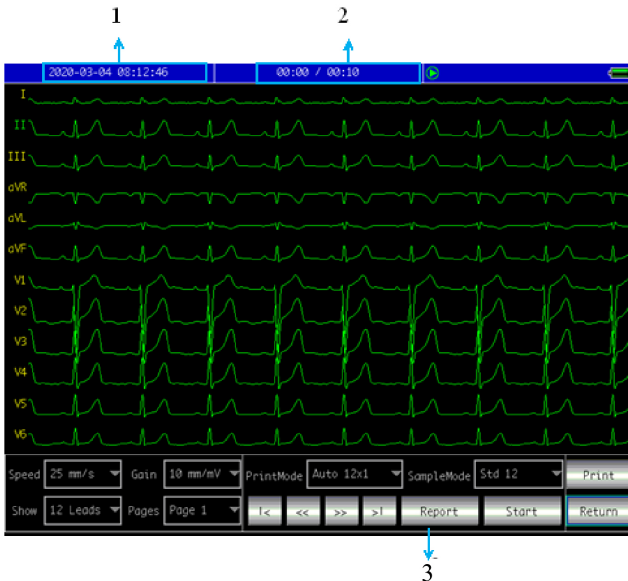

Figure 7-9



Status bar

- 1.It shows detailed examination time of the reviewed case.
- 2.The sampled time length of this case is displayed.

Setting field

- 3.To analyze data information and get diagnosis result of the case.

⚠️Note:

- 1.In this interface, user can use  button to change the print mode.
- 2.In this interface, user can use  button to print.
- 3.If lead-off occurs during sampling process, the reviewed waveform and the printed waveform will be marked with “*”.
- 4.If lead overload occurs during sampling process, the reviewed waveform and the printed waveform will be marked with “+”.

7.5 Date and time setup



In the main interface, click  to enter the following interface to set date and time.

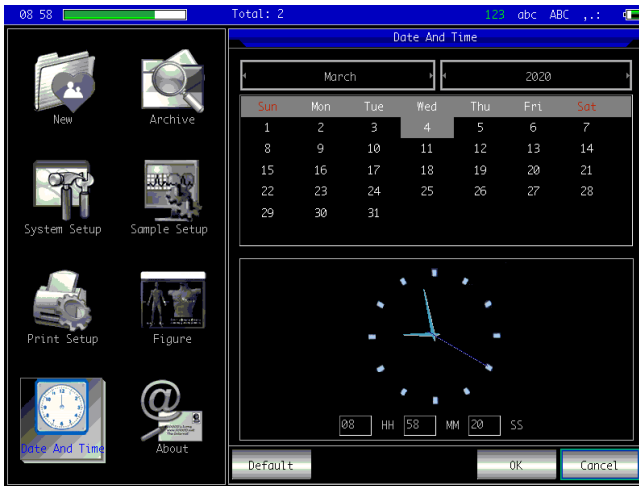







Figure 7-10

In current interface, user can switch the items via   buttons, and adjust the content of the item by   buttons. It can also be changed through the touch screen function, which is convenient and quick.

7.6 System setup



In the main interface, click  to enter the system setup interface. The optional

content of each setting item and its description are shown in the following table:

Item	Options	Description	
Back-light	[30Seconds]/[1Minute]/ [2Minutes]/[5Minutes]/ [10Minutes]/[Always On]	If there is no operation after reaching the set time, screen backlight will turn off. If it is set to “Always On”, the backlight will always keep on.	
Light-degree	[10%degree]/[20% degree]/ [30%degree]/[40% degree]/ [50%degree]/[60% degree]/ [70%degree]/[80% degree]/ [90%degree]/[100%degree]	After setting light degree, the screen will display different backlight strength.	
Auto Off	[None]/[1Minute]/[3 Minutes]/[5Minutes]/[10 Minutes]/[15Minutes]/[30 Minutes]/[60 Minutes]	If there is no operation after reaching the set time, the system will automatically turn off. If it is set to “None”, the system will always keep on.	
Low Power	[None]/[Only once]/[Always]	It determines the alarm method that the device uses in low power. If it is set to “None”, the system will not prompt for low power.	
AC filter	[50Hz]/[60Hz]	To set the parameters of AC filter.	
EMG filter	[25Hz]/[30Hz]/[35Hz]/[40 Hz]/[45Hz]	To set the parameters of EMG filter.	
DFT Filter	[0.05Hz]/[0.5Hz]/[1Hz]/[0. 15Hz]/[0.25Hz]/[0.32Hz]/[0.67Hz]/[0.01Hz]	To set the parameters of Baseline filter.	
Low-pass Filter	[OFF]/[75Hz]/[100Hz] /[150Hz]	To set the parameters of low pass filter.	
Language	[English]/[Chinese], etc	To set the default language of system.	
Hospital	0-64 characters	To fill in the name of hospital in report.	
Heartbeat Sound	ON/OFF	To turn on or off the heartbeat sound.	
K-B Sound	ON/OFF	Set to on, the button makes sound while pressing, set to off, there will be no sound.	
Demo Mode	ON/OFF	Set to on, the system will run in Demo mode; set to off, the system will run in sampling mode.	
Sync setup	Sync Mode	[USB]/[Wi-Fi]	Set the sync mode.
	Sync Host	_____	Sync the IP address of host.
	Sync Port	6000 by default	Set the sync serial port.
	MAC Addre ss	_____	It is updated automatically after connected.
Default	All above settings will restore to default after clicking this button.		

7.7 Sampling setup



In the main interface, click  to enter the sampling setup interface. The optional content of each setting item and its description are shown in the following table:

Item	Options	Description
AC Filter	ON/OFF	Turn on or off the AC filter.
EMG Filter	ON/OFF	Turn on or off the EMG filter.
DFT Filter	ON/OFF	Turn on or off the Baseline filter.
Show Style	[1leads]/[3leads]/[6leads]/ [12 leads]	Set the display method of ECG.
Sort Lead	[Routine Lead]/[Cabrera Lead]	Set the arrangement of the leads.
Show Gain	[2.5mm/mV]/[5mm/mV]/[10 mm/mV]/[20mm/mV]/[40m m/mV]	Set the gain of displayed ECG.
Show Speed	[5mm/s]/[6.25mm/s]/[10mm /s]/[12.5mm/s]/[25mm/s]/[50 mm/s]	Set the speed of displayed ECG.
Background Grid	[Show]/[Not Show]	Set to use the background grid or not.
Premature	0~100	The system will use the input value as a standard of judging premature beat.
Pause Time	1200~3000	The system will use the input value as a standard of judging beat pause.
Tachycardia	0~250	The system will use the input value as a standard of judging tachycardia.
Bradycardia	0~99	The system will use the input value as a standard of judging bradycardia.
Default	All above settings will restore to default after clicking this button.	

7.8 Print setup



In the main interface, click  to enter the print setup interface. The optional content of each setting item and its description are shown in the following table:

Item	Options	Description
Print Mode	[Auto 12×1]/[Auto 6×2+1]/[Auto 6×2+1_H]/[Auto 6×2]/[Auto 6×2_H]/[Auto 3×4+1]/[Auto 3×4+2]/[Auto	The system takes the selected option as default print mode.

	1×12]/[Rhythm 12]/[Rhythm 10]/[Rhythm 8]/ [Rhythm 6]	
Lead Gain	[Smart]/[Current]	The option selected will be used as printing gain mode. "Smart" means the system will adjust gain automatically to fit paper height; "Current" means it will use screen waveform gain as that of printing.
Auto Strip	[2.5 sec]/[3 sec]/[4 sec]/[5 sec]/[6 sec]/[8 sec]/[10 sec]/[15 sec]/[20 sec]/[25 sec]	The system takes the selected option as the print time length of each strip.
Rhythm Strip	[10 sec]/[15 sec]/[20 sec]/[25 sec]/[30 sec]	When "Print Mode" is set to "Rhythm 12" "Rhythm 10" "Rhythm 8" or "Rhythm 6", the system takes the selected option as the print time length of each waveform.
Average QRS	[3x4 + Mark]/[3×4]/[Not Print]	When "Print Mode" is set to "Auto" or "Rhythm", the system uses the selected format to print the average QRS waveform.
Auto-Diagnosis	[All]/[Only Data]/[Only Conclusion]/[Not Print]	The diagnosis contains data and conclusion two parts, which can be chosen by user as demand.
Period	[Off]/[per 1 min]/[per 2 min]/[per 3 min]/[per 5 min]/[per 10 min]/[per 20 min]/[per 30 min]/[per 60 min]	During the ECG acquisition process, the system will automatically activate the printing operation according to the selected time interval. When the printing mode is manual mode, the printing will output "Auto 12×1" format, otherwise, it will output according to the current setting mode.
Print Device	[Inside]/[Outside A4]	Choose to print out the ECG waveform by thermal printing system or USB external printer
Print Depth	[1]/[2]/[3]/[4]	Set the waveform depth according to necessary.
Timing Marker	ON/OFF	Set to display the time mark on the print paper or not
Arrhythmia	ON/OFF	Set to turn on or off the arrhythmia analysis

 **Note 1: The settings of auto strip, rhythm strip, average QRS, auto diagnosis and period are only optional in auto mode and rhythm mode.**

 **Note 2: If print time length is less than 8s, the sampling and analysis time will be 8s; if the print time length is equal to or greater than 8s, the sampling and analysis time keeps the same with print time.**

In the print setup interface, click “Adv-opr” to enter advanced setup interface. The optional content of each setting item and its description are shown in the following table:

Item	Options	Description
Auto-Print	ON/OFF	Set to open the automatic print or not
Data Type	[Begin Print]/[After Print]	Set to print the data before clicking the PRINT button, or after clicking
Rhythm 1	[I]/[II]/[III]/[aVR]/[aVL]/[aVF]/[V1]/[V2]/[V3]/[V4]/[V5]/[V6]	Set the rhythm lead that used for printing under rhythm mode
Rhythm 2	[I]/[II]/[III]/[aVR]/[aVL]/[aVF]/[V1]/[V2]/[V3]/[V4]/[V5]/[V6]	Set the “Auto 3*4+2” mode that used for printing under rhythm mode
Conclusion title	[Conclusions] by default	Set the printed conclusion title
Physician	[Physician]/[Specialist]	Set doctor’s signature in printed report

7.9 Lead placement



In the main interface, click  to view the schematic diagram of lead placement, the European Standard is shown as below:

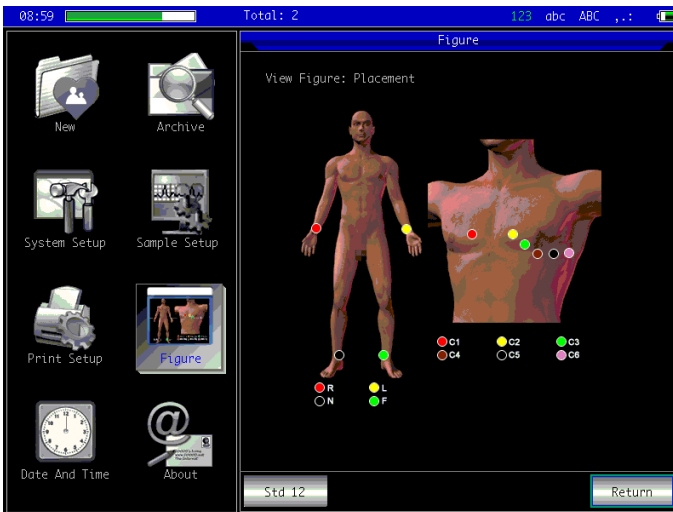

Figure 7-11

The American Standard is shown as below:

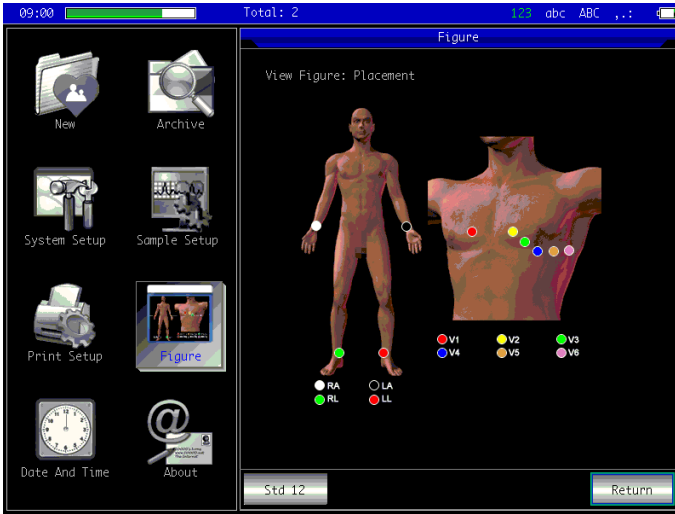



Figure 7-12

Click “Std 12” to switch the schematic diagram of lead placement of “Std 12” and “Add 6”.
Click “Return” to exit.

7.10 About



In the main interface, click  to view the information about the device, which including the following content:

1. App Version: the version number of current software
2. Firm Info: click it see the firmware information of the device.
3. Return: click it to exit the interface.

Chapter 8 Troubleshooting

8.1 Auto shutdown

- The battery is almost running out, which causes overdischarge protection circuit action.
- The voltage of AC power supply is too high, which causes overvoltage protection circuit action.

8.2 AC interference

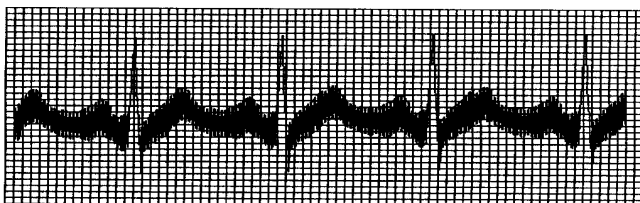

- Whether the device is grounded reliably?
- Whether the electrode or lead cable is connected correctly?
- Whether the electrodes and skin are daubed with enough conductive paste?.
- Whether the metal bed is grounded reliably?
- Whether the patient is touching the wall or metal parts of the bed?
- Whether the patient touches other people?
- Whether there is high power electric equipment working nearby? Such as X-ray machine or ultrasonic device, etc.

⚠ Note: If the interference can not be removed after taking above measures, please use a

AC filter.

8.3 EMG interference

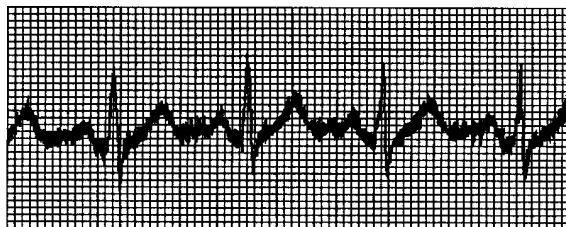

- Whether the room is comfortable?
- Whether the patient is nervous?
- Whether the bed space is narrow?
- Whether patient speaks during recording?
- Whether the limb electrode is too tight?

⚠ Note: If the interference can not be removed after taking above measures, please use a
EMG filter. The ECG waveform recorded at this time will be slightly attenuated.

8.4 Baseline drift

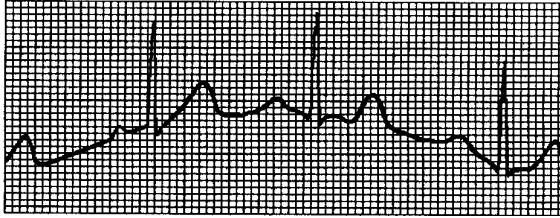

- Whether the electrode installation is stable?
- Whether the connection of lead cables or electrodes is reliable?
- Whether the electrodes and patient skin are cleaned and are daubed with enough conductive paste?
- Whether it is caused by patient's movement or breathing?
- Whether the electrodes or leads are in bad connection?

⚠Note: If the interference can not be removed after taking above measures, please use a baseline filter.

8.5 Troubleshooting list

Phenomenon	Cause of failure	Solutions
Too large interference, disorderly waveform	<ol style="list-style-type: none"> 1. Grounding cable is not connected reliably. 2. Lead cables are not connected reliably. 3. There is AC interference. 4. Patient is nervous and can not keep quiet. 	<ol style="list-style-type: none"> 1. Check the power cord and lead cables. 2. Let the patient prepare for the measurement.
Baseline burr	<ol style="list-style-type: none"> 1. AC interference is large. 2. Patient nervous, and EMG interference is large. 	<ol style="list-style-type: none"> 1. Improve the environment. 2. If the bed is made of steel, replace it. 3. The power cable and lead cables are not parallel or too close to each other.
Not regular waveform, large up-and-down, beeline figure	<ol style="list-style-type: none"> 1. Bad electrode conductivity. 2. Low battery. 3. Bad connection between electrodes and patient skin. 4. Loose connection between lead cables and the 	<ol style="list-style-type: none"> 1. Use alcohol of high quality. 2. Clean electrode slice and the skin under the electrode with alcohol. 3. Charge the battery.







	<p>device's plug.</p> <p>5. Bad connection between electrodes and lead cables.</p>	
Baseline draft	<p>1. Low power.</p> <p>2. Patient movement.</p>	<p>1. Charge the battery.</p> <p>2. Keep patient still.</p>
Unclear waveform	<p>1. Low battery.</p> <p>2. The printer head surface is dirty.</p> <p>3. The thermal paper problem.</p>	<p>1. Charge the battery.</p> <p>2. Cut off the power, clean the printer head with alcohol, air dry.</p> <p>3. Replace the thermal print paper with specified one.</p>

Chapter 9 Maintenance

9.1 Battery

9.1.1 The device is designed with built-in full-sealed and maintenance-free rechargeable lithium battery, also equipped with perfect auto-charging-discharging monitor system. When the device is connected to AC power supply, turn the mains power switch to ON state, the battery will be charged automatically. Battery status will be displayed on right edge of LCD screen in powering on state, as shown in Table 9-1. After absolutely discharged, the battery needs 4.5 hours to charge to 90%, and 5 hours to charge to full capacity.

Table 9-1 Battery status display

No.	Icon	Description
a		The battery status is unknown, generally it appears within 1 min after turning on.
b		Using AC power supply, and the battery is full or no battery in the device
c		Using battery, and battery is full
d		Using battery, and battery level is 3/4 of battery full
e		Using battery, and battery level is 1/2 of battery full
f		Using battery, and battery level is 1/4 of battery full
g		Using battery, and the battery is low. It is recommended to charge the battery before use or adopt AC power supply.

⚠️Note: When charging the battery, the displayed status of battery level switches between icon f to icon c.

9.1.2 The device can continuously print for 3 hours or work for more than 10 hours in standby mode when battery is completely charged. When the device is powered by battery, a battery icon will be displayed on the LCD screen, showing the battery capacity in 5 modes. When the battery capacity is too low for the device to operate, the device will turn off automatically to avoid permanent damage to the battery.

⚠️Note: The above data is obtained by printing demo waveform under the test environment of temperature 25°C, speed 25mm/s and gain 10mm/mV. In actual use, the operation time may be shorten due to operation condition and environment.

9.1.3 The battery should be recharged in time after discharged completely. If not used for long period, the battery should be recharged every 3 months, which can extend the life of the battery.

9.1.4 When the battery can not be recharged or works no more than 10 minutes after fully charged, please replace the battery.

⚠️Note

- **Do not try to dismantle the sealed battery without permission. The replacement of battery shall be carried out by professional maintenance personal authorized by our company, and the same model of rechargeable battery provided by our company**

should be used.

- **Do not touch the positive and negative terminals of the battery directly with wire, otherwise there is a danger of fire.**
- **Do not use the battery near fire sources or in environments where the temperature exceeds 60°C. Do not heat the battery or throw it into fire, water and avoid splashed by water.**
- **Do not puncture, hammer or strike the battery or destroy it by other ways, otherwise it will cause battery overheat, smoke, deform or burn dangers.**
- **Keep away from the battery when it appears leakage or emitting unpleasant smell. If the battery electrolyte leaks onto the skin or clothes, clean with water immediately. If the electrolyte accidentally enters your eyes, do not rub your eyes, immediately clean with water and see a doctor.**
- **If the battery reaches its service life, or battery smell, deform, discolor or distorted appears, please stop using the battery and dispose it in accordance with local regulations.**

9.2 Recording paper

In order to ensure the quality of the ECG waveform, please use the high-speed thermal recording paper supplied or specified by the company. If you use unspecified recording paper, the recorded ECG waveform may be blurred, faded, and the paper feeding may not be smooth. This may even increase the wear of the device and shorten the service life of important parts such as the thermal print head. For information on how to purchase such recording paper, please contact your dealer or the company. Please be careful!

9.2.1 When using recording paper, it is absolutely not allowed to use recording paper with wax on the surface or in grayish/black color. Otherwise, the wax will stick to the heating part of the print head, resulting in abnormal work or damage of the print head.

9.2.2 High temperature, humidity and sunlight may cause the recording paper to change color. Please keep the recording paper in a dry and cool place.

9.2.3 Please do not place the recording paper under fluorescent light for a long time, otherwise it will affect the recording effect.

9.2.4 Please do not to put the recording paper together with the PVC plastic, otherwise the color of recording paper will change.

9.2.5 Please use the recording paper with specified dimension. Recording paper that does not meet the requirements may damage the thermal print head or silicone rubber roller.

9.3 Maintenance after use

9.3.1 Press  button to shutdown the device.

9.3.2 Unplug the power cord and lead cables. Hold the header of plug to disconnect, and do not pull the cable with force directly.

9.3.3 Clean the device and accessories, cover them up to against dust.

9.3.4 Store the device in a cool and dry place, avoid strong vibration when moving.

9.3.5 When cleaning the device, do not immerse it in the cleaner. Power supply must be cut off before cleaning. Use neutral detergents for cleaning. Do not use any detergent or disinfectant containing alcohol.

9.4 Lead cables and electrodes

9.4.1 The connectivity of the lead cable can be detected by the multimeter. Check whether each wire of the lead cable is in good contact according to the following table. The resistance of each wire from the electrode plug to the corresponding pin in the lead cable plug should be less than 10Ω. The integrity of the lead cable must be checked regularly. Any lead wire damage will cause a false waveform of the corresponding lead or all leads on the ECG. The lead cable can be cleaned with neutral solvent. Do not use the detergent or germicide containing alcohol (Please do not immerse the lead cables in liquid for cleaning).

⚠️Note: The resistance of lead cable with defibrillation-proof function protection function is about 10KΩ.

Table 9-2 Lead cable mark and pin position table

Mark	L	R	C1	C2	C3	C4	C5	C6	F	N
Pin position	10	9	12	1	2	3	4	5	11	14

9.4.2 Bending or knotting will shorten the service life of the lead cable. When using it, please straighten the lead cable first.

9.4.3 The electrode should be well stored. After long time use, the surface of the electrode may oxidize and discolor due to corrosion and other factors, which may affect the signal acquisition. In this case, the electrode must be replaced.

9.5 Silicone rubber roller

The silicone rubber roller should be smooth and free of stains, otherwise it will affect the ECG recording effect. In order to remove the stains on the roller, please use a clean soft cloth dampened with a small amount of alcohol to wipe it along the longitudinal direction, and scroll the roller in the paper conveying direction while wiping until it is clean.

9.6 Cleaning of thermal print head

Dirt and dust on the surface of the TPH can affect the clarity of the waveform. To clean the print head surface, open the paper compartment cover after turning off the device, use a clean and soft cloth dampened with alcohol to wipe the surface gently. For the residual stains on print head, moist it with a little alcohol first, then wipe with a soft cloth. Never use hard objects to scratch the surface, otherwise the print head will be damaged. Wait until the alcohol has evaporated, then close the paper compartment cover. The print head should be cleaned at least once a month during normal use.

9.7 Fuse replacement

Use a cross screwdriver to remove the fuse holder in the direction of the arrow (counterclockwise), and replace the damaged fuse with a primary fuse provided or approved by our company. Screw the fuse holder in the opposite direction to fasten it. The replacement method is shown in Figure 9-1:



Figure 9-1 Replacing the fuse

Note:

- **If the fuse blows again after replacing a fuse of the same specification, the device may exist other problems, please cut off the power supply and contact the after-sales service of our company or designated service center.**
- **Press the fuse holder downward and rotate it counterclockwise as shown in Figure 9-1. After removing the damaged fuse replacing a new one, press down the fuse holder and rotate it clockwise.**

9.8 Disposal of product scrap

The disposal of packaging materials, waste battery and end-of-life device should obey the local laws and regulations, and user should treat the scrapped products and materials properly according to the laws and regulations, and try to support the classification and recycling work.

9.9 Others

9.9.1 Do not open the device enclosure to avoid electric shock danger.

9.9.2 The device associated circuit schematics and critical parts list are only available to authorized service station or maintenance personnel, who is responsible for maintenance of the device.

9.9.3 The device belongs to measuring instrument. User should send the device to national designated inspection institution for inspection according to the requirements of the national metrological verification procedure. The device shall be inspected at least once per year, and all the accessories should be inspected and maintained regularly (at least once every six months).

Chapter 10 Packing List and Accessories

10.1 Accompanying accessories

When the device is shipped from the factory, the intact packaging should contain the following contents, as shown in Table 10-1:

Table 10-1 Packing list and accessories

Name	Quantity
Electrocardiograph	1 pc
Chest electrodes (suction cup/electrode slice)	1 set (6 pcs)
Limb electrodes (limb clip)	1 set (4 pcs)
ECG lead cable	1 pc
Potential equalization wire	1 pc
Power cord	1pc
User manual	1 pc
Recording paper	1 pc

10.2 Notes

10.2.1 Please follow the instructions on the package when opening the package.

10.2.2 After unpacking, please check the accessories and accompanying documents in accordance with the packing list, then start inspecting the device.

10.2.3 If the packaging content does not meet the requirement or the device does not work properly, please contact our company immediately.

10.2.4 Please use the accessories provided by our company, otherwise the performance and safety of the device may be affected. If accessories provided by other company need to be used, please first consult the after-sales service of our company, or we will not responsible for any caused damages.

10.2.5 The package shall be kept properly for future use in regular maintenance or device repair.

Appendix I ECG Automated Measurement&Interpretation Guide

1. Preface

The appendix describes the functions of ECG automated measurement and automated interpretation. It explains the specific implementation method, algorithm and formulas related to these two functions, as well as the content output by the automated measurement and automated interpretation.

According to the requirement of *IEC60601-2-51:2003 Medical electrical equipment - Part 2-51: Particular requirements for safety, including essential performance, of recording and analysing single channel and multichannel electrocardiographs, Clause 50 Accuracy of operating data*, the appendix gives a description of verification process and results of the performance for automated measurement and automated interpretation.

2. Automated measurement parameters and Automated interpretation items

The output measurement parameter, interpretation item and others that require explanation are as follows:

2.1 Measurement parameters

No.	Parameter	Unit
1	HR	bpm
2	PR-interval	ms
3	P-duration	ms
4	QRS-duration	ms
5	T-duration	ms
6	QT/QTc	ms
7	P/QRS/T electric axis	deg
8	R(V5)/S(V1)	mV
9	R(V5)+S(V1)	mV

2.2 Interpretation items

No.	Item
1	No abnormal
2	Sinus mode Bradycardia
3	Sinus mode Tachycardia
4	Left atrium Hypertrophy
5	Right atrium Hypertrophy
6	Dual atrium Hypertrophy
7	QRS low voltage
8	Cardiac electric axis normal
9	Left axis deviation
10	Right axis deviation

11	Completeness Right Bundle branch block
12	Completeness Left Bundle branch block
13	No Completeness Right Bundle branch block
14	No Completeness Left Bundle branch block
15	V1 shows RSR' type
16	Left anterior fascicular block
17	Left posterior fascicular block
18	Left ventricular hypertrophy
19	Right ventricular hypertrophy
20	I atrioventricular block
21	Early anteroseptal MI
22	Possible acute forepart anteroseptal MI
23	Old anteroseptal MI
24	Early anterior MI
25	Possible acute anterior MI
26	Old anterior MI
27	Early extensive anterior MI
28	Possible acute extensive anterior MI
29	Old extensive anterior MI
30	Early apical MI
31	Acute apical MI
32	Old apical MI
33	Early anterolateral MI
34	Possible acute anterolateral MI
35	Old anterolateral MI
36	Early high lateral MI
37	Possible acute high lateral MI
38	Old high lateral MI
39	Early inferior MI
40	Possible acute inferior MI
41	Old inferior MI
42	Early inferolateral MI
43	Possible acute inferolateral MI
44	Old inferolateral MI

45	ST depression, mild anteroseptal myocardial ischemia
46	ST depression, mild anterior myocardial ischemia
47	ST depression, mild extensive anterior myocardial ischemia
48	ST depression, mild apical myocardial ischemia
49	ST depression, mild anterolateral myocardial ischemia
50	ST depression, mild high lateral myocardial ischemia
51	ST depression, mild inferior myocardial ischemia
52	ST depression, mild inferolateral myocardial ischemia
53	ST depression, anteroseptal myocardial ischemia
54	ST depression, anterior myocardial ischemia
55	ST depression, extensive anterior myocardial ischemia
56	ST depression, apical myocardial ischemia
57	ST depression, anterolateral myocardial ischemia
58	ST depression, high lateral myocardial ischemia
59	ST depression, inferior myocardial ischemia
60	ST depression, inferolateral myocardial ischemia

2.3 Intended use

The intended use of the Automated Measurement&Interpretation function is shown as below:

Application and diagnosis	To detect the abnormal of heart of human body, examination items refer to above description
Population	Teenagers and adults, age range: 12-87
Application site	hospitals
Accuracy	The accuracy of this function is reflected by the balance performance of sensitivity and specificity.
Others	This function does not generate any alarm when using, so it should be operated by professional or trained personal.

3. Algorithm description

This section describes the algorithm, formulas and judgment conditions for interpretation items related to functions of ECG automated measurement and automated interpretation.

The 12-lead sync ECG waveform passes through the filter (AC, EMG, DFT (if has, and open)) into the module of automated measurement and automated interpretation.

The module of automated measurement and automated interpretation mainly includes process of find the cardiac impulse location, find the beginning/end for each wave, amplitude calculation, parameters calculation, and interpretations judgment based on known parameters.

The workflow is shown as below:

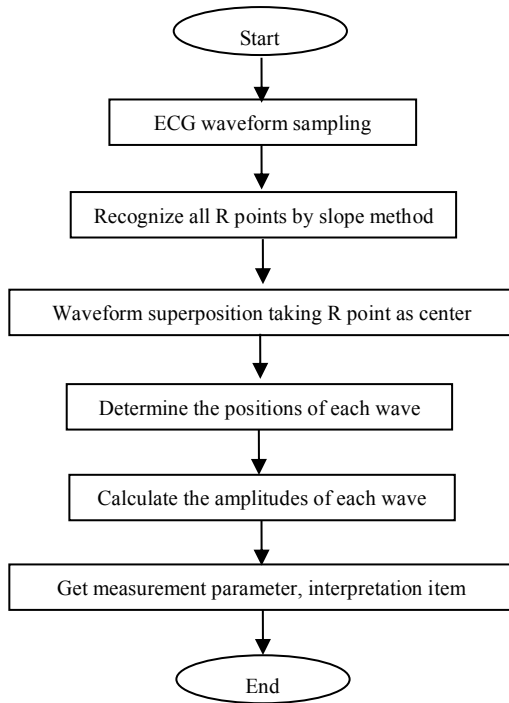

3.1 Find the cardiac impulse location

1) Data preprocessing, obtain the absolute value trend of slope for each lead; then superimpose each absolute value, obtain the superimposed graph of absolute value of slope.

2) Smoothing filter the superimposed graph on average of width 80ms, obtain the analytical data source DDD.

3) Find the cardiac impulse location, give an initial threshold for searching, orderly scan the data in the analytical data source DDD, then compare it with the threshold value:

When the value is greater than the threshold, it may be the beginning of qrs-complex.

If the distance from the previous qrs-complex to the current location is less than 150ms, then give up the location.

Otherwise, take the 1/4 of threshold value as a reference, find the beginning of qrs-complex within 100ms before the current location.

When the value is less than the threshold value, it may be the end of qrs-complex. Take the 1/4 of threshold value as a reference, find the end of qrs-complex.

If the found qrs-complex is wide, this qrs-complex shall be excluded. Otherwise, save the found qrs-complex.

4) Locate: after found the qrs-complex, search the max value point between the beginning point and end point in the ecg original data, mark the point as cardiac impulse location.

5) Dynamically threshold adjustment: after found the cardiac impulse location, use the value at the cardiac impulse location for the dynamically adaptive adjustment of the threshold value. Define the threshold value as $1/3$ of the average of the nearest three cardiac impulses.

6) After found the cardiac impulse location, compute the RR-interval and accumulate it with the previous RR-intervals, then count the number of accumulated RR-intervals.

7) Continue searching until the end of data, and calculate the global average value for RR-intervals at the same time.

3.2 Find the beginning/end for each wave

The beginning/end of qrs-complex has been approached in above cardiac impulse locating process, but it is mainly in order to assist to find the cardiac impulse location; in addition, the location is searched based on the slope threshold value, which is imprecise. Here, according to the found cardiac impulse location, the beginning/end of qrs-complex will be sought accurately. Name the cardiac impulse location as the peak of R-wave.

1. Read data

1) Read one data of qrs-complex: take the peak of R-wave as reference, locate directly to the original ecg file, read a piece of data containing the qrs-complex.

2) Preprocessing: superimpose the absolute value of slope for 12-lead signals.

3) Use the preprocessed data to carry on the searching of QRS-complex, P-wave and T-wave as the followings.

4) Read the next data of qrs-complex, repeat step 2 and step 3 until the analyzing of all qrs-complex are finished.

2. Find QRS-complex

1) Calculate the threshold value of S-wave: search the minimal value within 200ms after the peak of R-wave, take the value that equals to minimal value plus 0.4, as the threshold value for finding the end of S-wave.

2) Find the beginning of Q-wave: take 0.5 as the threshold value, search forwardly starting from R-wave, a point that less than the threshold value, within 0ms-200ms before the peak of R-wave, which is the beginning of Q-wave.

3) Find the end of S-wave: search backwardly starting from R-wave, a point that less than the threshold value of the end of S-wave, within 0ms-200ms after the peak of R-wave, which is the end of S-wave.

3. Find P-wave

1) Peak of P-wave: search the max value within 30ms-100ms before the beginning of Q-wave, temporarily mark the point as the peak of P-wave.

2) Find the end of P-wave: search the minimal value between the peak of P-wave and the beginning of Q-wave, the minimal value plus 0.05 is the threshold value, use the threshold value to find the end of P-wave.

3) Find the beginning of P-wave: search the minimal value within 150ms before the peak of P-wave, the minimal value plus 0.06 is the threshold value, use the threshold value to find the beginning of P-wave.

4) If the found P-wave is narrow, research the P-wave according to the following steps.

5) Change the searching range of 30ms-100ms to 100ms-350ms in step 1, repeat step 1-4.

6) If the found P-wave is still narrow, it means that P-wave doesn't exist.

4. Find T-wave

1) Peak of T-wave: search the max value within 30ms-300ms after the end of QRS-complex, save it as the peak of T-wave.

2) Threshold value of the beginning of T-wave: search the minimal value within 0ms-100ms after the end of QRS-complex, the minimal value plus 1/10 of the peak value of T-wave is the threshold for finding the beginning of T-wave.

3) Threshold value of the end of T-wave: search the minimal value within 200ms after the peak of T-wave, the minimal value plus 1/10 of the peak value of T-wave is the threshold for finding the end of T-wave.

4) Find the beginning of T-wave: in the range between the minimal value in step2 and the peak of T-wave, find a point that less than the threshold value of the beginning of T-wave, the point is the beginning of T-wave.

5) Find the end of T-wave: in the range between the minimal value in step3 and the peak of T-wave, find a point that less than the threshold value of the end of T-wave, the point is the end of T-wave.

5. Explanation of equipotential segment

In searching the QRS-complex, this algorithm adopts the analysis method of superposition of the slopes for all leads, therefore, the equipotential segments before and after the QRS-complex are partly included in the start and end points of the QRS-complex. It is depends on the number of leads containing equipotential segments. If there are more leads containing equipotential segments, the slope value will be smaller after superposition, so it is difficult to meet the threshold condition, and only a small part of the equipotential segments is counted to the start and end points of the QRS-complex. On the contrary, if there are less leads containing equipotential segments, a large part of the equipotential segments will be counted to the start and end points of the QRS-complex. Anyway, the equipotential segments before and after the QRS-complex are partly included in the QRS-complex duration.

3.3 Amplitude measurement

After finding the position of each wave, i.e. the start and end points of P wave, QRS complex and T wave, use the following method to measure P, Q, R, S, ST and T waves of each lead.

1. P-wave

Calculate the average value of the data 20ms before the start point of P wave, and use this average value as the baseline of P wave. Find the max value between the start point and end point of P wave, the difference between the max value and the baseline would be the amplitude of P wave.

2. Q/R/S wave

Calculate the average value of the data 10-30ms before the start point of QRS complex, and use this average value as the baseline of QRS complex. Search boundary points that exceeding the baseline from the start point of Q wave to the end point of S wave. Each adjacent two boundary points forms a sub-wave. Determine whether each sub-wave is a recognizable minimum wave

(see the definition below). If it is a recognizable minimum wave, first identify its direction. If it is above the QRS baseline, it is R wave, if it is below the baseline, it is Q wave or S wave. Find the extreme value of this wave, and the difference between the extreme value and the baseline is the amplitude of Q/R/S wave.

 Note: If there is only one downward wave, its amplitude should be respectively recorded in the amplitude of Q wave and S wave.

3. ST segment

Take above baseline of QRS complex as the ST baseline. Calculate the differences between the ST baseline and the points at 40ms and 60ms after the end point of QRS complex, and calculate the average value of these two differences, the average value is the amplitude of ST segment.

4. T-wave

Calculate the average value of the data 20-50ms after the end point of T wave, and average this value with the QRS baseline in 2, then use the result as the baseline of T wave. Find the max value between the start point and end point of T wave, the difference between the max value and the baseline would be the amplitude of T wave.

5. Recognition of minimum wave

The minimum wave can be recognized by the algorithm according to the requirement of IEC60601-2-51:2003 Medical electrical equipment - Part 2-51: Particular requirements for safety, including essential performance, of recording and analysing single channel and multichannel electrocardiographs, Annex GG, Clause GG.5 Definition of waveforms, measurement of minimum waves. The wave that meet the following conditions is the minimum wave that can be recognized by the algorithm.

- 1) The signal part under consideration shows clearly two opposite slopes with at least one turning point in between;
- 2) The signal part under consideration deviates at least $30 \mu V$ from the reference level for a duration of at least 6ms;
- 3) The minimum observable duration of wave under consideration is 12ms and amplitude $\geq 30 \mu V$.

3.4 Calculation after intervals determination

The following parameters are determined according to the requirement of IEC60601-2-51:2003 Medical electrical equipment - Part 2-51: Particular requirements for safety, including essential performance, of recording and analysing single channel and multichannel electrocardiographs, Annex GG Definitions and rules for the measurement of ELECTROCARDIOGRAMS.

No.	Parameter	Calculation
1	HR	$60 / RR^{①}$
2	PR-interval	$Qs^{②} - Ps^{③}$
3	P-duration	$Pe^{④} - Ps^{③}$
4	QRS-duration	$Se^{⑤} - Qs^{②}$

5	T-duration	$Te^{⑦} - Ts^{⑥}$
6	QT	$Te^{⑦} - Qs^{②}$
7	QTc	$\frac{QT}{\sqrt{RR}}^{③}$
8	P/QRS/T electric axis	<p>Electric axis formula:</p> $\frac{\arctan(2.0 \times (S_{III} + S_I), S_I \times \sqrt{3}) \times 180}{PI}$ <p>⑧</p> <p>P electric axis:</p> <p>S_{III}: voltage sum from the beginning point to the end point of P-wave on lead III</p> <p>S_I: voltage sum from the beginning point to the end point of P-wave on lead I</p> <p>QRS electric axis:</p> <p>S_{III}: voltage sum from the beginning point to the end point of QRS-complex on lead III</p> <p>S_I: voltage sum from the beginning point to the end point of QRS-complex on lead I</p> <p>T electric axis:</p> <p>S_{III}: voltage sum from the beginning point to the end point of T-wave on lead III</p> <p>S_I: voltage sum from the beginning point to the end point of T-wave on lead I</p>
9	R(V5)	Height (voltage value) of R-wave on lead V5
10	S(V1)	Height (voltage value) of S-wave on lead V1

 Note:

- ① RR: RR-interval
- ② Qs: beginning of the Q-wave
- ③ Ps: beginning of the P-wave

- ④ Pe: end of the P-wave
- ⑤ Se: end of the S-wave
- ⑥ Ts: beginning of the T-wave
- ⑦ Te: end of the T-wave
- ⑧ PI: 3.1415926

3.5 Interpretations judgment based on parameters

No.	Item	Rule of interpretation
1	No abnormal	No any abnormal are detected
2	Sinus mode Bradycardia	Sinus P-wave, PR-interval between 110ms-210ms, $HR \leq */min$, general $*=50$
3	Sinus mode Tachycardia	Sinus P-wave, PR-interval between 110ms-210ms, $HR \geq */min$, general $*=100$
4	Left atrium Hypertrophy	P-wave of leads I, II, aVL shall meet the conditions: width increase of P-wave $\geq 110ms$, or P-wave displays in double-peak type, value of peak to peak $\geq 40ms$
5	Right atrium Hypertrophy	For leads I, II, aVF, amplitude of P-wave $\geq 0.25mV$, or P-wave is sharp
6	Dual atrium Hypertrophy	For leads I, II, aVF, amplitude of P-wave $\geq 0.25mV$ and P-wave duration $> 110ms$
7	QRS low voltage	Voltage of I-aVF limb leads $< 0.5mV$, and voltage of V1-V6 chest leads $< 0.8mV$
8	Cardiac electric axis normal	QRS-axis between 30 to 90 degree
9	Left axis deviation	QRS-axis between -90 to -30 degree
10	Right axis deviation	QRS-axis between 120 to 180 degree
11	Completeness Right Bundle branch block	QRS-duration $> 120ms$, R-wave of lead V1 or aVR is wide (width of R-wave $> 80ms$)
12	Completeness Left Bundle branch block	QRS-duration $> 120ms$, R-wave of lead V5 or V6 is wide
13	No Completeness Right Bundle branch block	QRS-duration $< 120ms$, R-wave of lead V1 or aVR is wide (width of R-wave $> 80ms$)
14	No Completeness Left Bundle branch block	QRS-duration $< 120ms$, R-wave of lead V5 or V6 is wide (width of R-wave $> 80ms$)
15	V1 shows RSR' type	QRS-complex of lead V1 is RSR' type
16	Left anterior fascicular block	QRS-duration $< 110ms$, QRS-axis < -30 degree, lead I and lead aVL are qR type, and Q-wave duration $< 20ms$, lead II, III and aVF

		are rS type.
17	Left posterior fascicular block	QRS-duration<110ms, QRS-axis >90 degree, lead I and lead aVL are rS type, lead II, III and aVF are qR type, and Q-wave of lead II and III <20ms.
18	Left ventricular hypertrophy	R amplitude of lead I >1.5mV, R amplitude of lead V5 >2.5mV, R amplitude of lead aVL >1.2mV, R amplitude of lead aVF >2mV, R amplitude of lead V5 minus S amplitude of lead V1 >4mV (male) or 3.5mV (female).
19	Right ventricular hypertrophy	R amplitude of lead aVR >0.5mV, R amplitude of lead V1 >1mV, R amplitude of lead V1 minus S amplitude of lead V5 >1.2mV, R amplitude of lead V1 is larger than S amplitude, R amplitude of lead V5 is smaller than S amplitude.
20	I atrioventricular block	PQ interval >210ms
21	Early anteroseptal MI	Early myocardial infarction change of leads V1, V2, V3, no change of leads V4, V5.
22	Possible acute forepart anteroseptal MI	Acute myocardial infarction change of leads V1, V2, V3, no change of leads V4, V5.
23	Old anteroseptal MI	Old myocardial infarction change of leads V1, V2, V3, no change of leads V4, V5.
24	Early anterior MI	Early myocardial infarction change of leads V3, V4, V5, no change of leads V1, V2, V6.
25	Possible acute anterior MI	Acute myocardial infarction change of leads V3, V4, V5, no change of leads V1, V2, V6.
26	Old anterior MI	Old myocardial infarction change of leads V3, V4, V5, no change of leads V1, V2, V6.
27	Early extensive anterior MI	Early myocardial infarction change of leads V1, V2, V3, V4, V5.
28	Possible acute extensive anterior MI	Acute myocardial infarction change of leads V1, V2, V3, V4, V5.
29	Old extensive anterior MI	Old myocardial infarction change of leads V1, V2, V3, V4, V5.

30	Early apical MI	Early myocardial infarction change of leads V4, V5, no change of leads V1, V2, V3.
31	Acute apical MI	Acute myocardial infarction change of leads V4, V5, no change of leads V1, V2, V3.
32	Old apical MI	Old myocardial infarction change of leads V4, V5, no change of leads V1, V2, V3.
33	Early anterolateral MI	Early myocardial infarction change of leads I, aVL, V4, V5, V6
34	Possible acute anterolateral MI	Acute myocardial infarction change of leads I, aVL, V4, V5, V6.
35	Old anterolateral MI	Old myocardial infarction change of leads I, aVL, V4, V5, V6
36	Early high lateral MI	Early myocardial infarction change of leads I, aVL, no change of leads II, III, aVF, V4, V5, V6.
37	Possible acute high lateral MI	Acute myocardial infarction change of leads I, aVL, no change of leads II, III, aVF, V4, V5, V6.
38	Old high lateral MI	Old myocardial infarction change of leads I, aVL, no change of leads II, III, aVF, V4, V5, V6.
39	Early inferior MI	Early myocardial infarction change of leads II, III, aVF, no change of leads I, aVL.
40	Possible acute inferior MI	Acute myocardial infarction change of leads II, III, aVF, no change of leads I, aVL.
41	Old inferior MI	Old myocardial infarction change of leads II, III, aVF, no change of leads I, aVL.
42	Early inferolateral MI	Early myocardial infarction change of leads I, II, III, aVL, aVF.
43	Possible acute inferolateral MI	Acute myocardial infarction change of leads I, II, III, aVL, aVF.
44	Old inferolateral MI	Old myocardial infarction change of leads I, II, III, aVL, aVF.
45	ST depression, mild anteroseptal myocardial ischemia	Mild ST-segment depression of leads V1, V2, V3, and no change of leads V4, V5.
46	ST depression, mild anterior	Mild ST-segment depression of leads V3, V4,

	myocardial ischemia	V5, and no change of leads V1, V2, V6.
47	ST depression, mild extensive anterior myocardial ischemia	Mild ST-segment depression of leads V1, V2, V3, V4, V5.
48	ST depression, mild apical myocardial ischemia	Mild ST-segment depression of leads V4, V5, and no change of leads V1, V2, V3.
49	ST depression, mild anterolateral myocardial ischemia	Mild ST-segment depression of leads I, aVL, V4, V5, V6.
50	ST depression, mild high lateral myocardial ischemia	Mild ST-segment depression of leads I, aVL, and no change of leads II, III, aVF, V4, V5, V6.
51	ST depression, mild inferior myocardial ischemia	Mild ST-segment depression of leads II, III, aVF, and no change of leads I, aVL.
52	ST depression, mild inferolateral myocardial ischemia	Mild ST-segment depression of leads I, II, III, aVL, aVF.
53	ST depression, anteroseptal myocardial ischemia	Severe ST-segment depression of leads V1, V2, V3, and no change of leads V4, V5.
54	ST depression, anterior myocardial ischemia	Severe ST-segment depression of leads V3, V4, V5, and no change of leads V1, V2, V6.
55	ST depression, extensive anterior myocardial ischemia	Severe ST-segment depression of leads V1, V2, V3, V4, V5.
56	ST depression, apical myocardial ischemia	Severe ST-segment depression of leads V4, V5, and no change of leads V1, V2, V3.
57	ST depression, anterolateral myocardial ischemia	Severe ST-segment depression of leads I, aVL, V4, V5, V6.
58	ST depression, high lateral myocardial ischemia	Severe ST-segment depression of leads I, aVL, and no change of leads II, III, aVF, V4, V5, V6.
59	ST depression, inferior myocardial ischemia	Severe ST-segment depression of leads II, III, aVF, and no change of leads I, aVL.
60	ST depression, inferolateral myocardial ischemia	Severe ST-segment depression of leads I, II, III, aVL, aVF.

 **Note:**

Early myocardial infarction: normal Q-wave, ST elevation or ST slope elevation
 Acute myocardial infarction: abnormal Q-wave, ST elevation or ST slope elevation
 Old myocardial infarction: abnormal Q-wave, no ST elevation.
 Abnormal Q-wave:

For leads I, II, III, avR, avL, avF, V3, V4, V5, V6, voltage of Q-wave <-0.3mV, or 4 times of negative wave of Q-wave> voltage of R-wave and R'-wave, and/or Q-duration>40ms.

For leads V1, V2, voltage of Q-wave <-0.08mV and Q-duration>10ms.

ST elevation:

For leads I, II, III, avR, avL, avF, V4, V5, V6, the voltage of ST segment at 60ms point >0.1mV, and for leads V1, V2, V3, the voltage at 60ms point >0.3mV.

ST slope elevation:

Voltage of ST segment at 20ms point>=voltage of J point, voltage at 40ms point >= the one at 20ms, voltage at 60ms point >= the one at 40ms, with change of ST elevation.

4. Data sources and data preprocessing

4.1 Data sources

According to the requirement of *IEC60601-2-51:2003 Medical electrical equipment - Part 2-51: Particular requirements for safety, including essential performance, of recording and analysing single channel and multichannel electrocardiograph*, the CSE measurement database, CSE diagnostic database, CTS calibration database and customized data shall be used to evaluate the function of automated measurements and automated interpretations.

Verification	Database	Database items
Automated measurement	CTS database	CAL05000 CAL10000 CAL15000 CAL20000 CAL20002 CAL20100 CAL20110 CAL20160 CAL20200 CAL20210 CAL20260 CAL20500 CAL30000 ANE20000 ANE20001 ANE20002
	CSE measurement database	MA_0001~MA0125
Automated interpretation	CSE diagnostic database	D_0001~D_1220
	Customized data	000001~000549

4.2 CTS introduction

The CTS computerized ECG conformance testing project was launched in 1989 by the European Union. This project laid the foundation for computerized ECG conformance testing service. Currently, about 20 types of waveform have been designed derived from the test signals having an infinite length, these signals are part of the CTS-ECG test database, and have proven their effectiveness in a series of official tests. According to the requirement of *IEC60601-2-51:2003 Medical electrical equipment - Part 2-51: Particular requirements for safety, including essential performance, of recording and analysing single channel and multichannel electrocardiograph Clause 50.101.1*, 13 data (CAL05000, CAL10000, CAL15000, CAL20000, CAL20002, CAL20100, CAL20110, CAL20160, CAL20200, CAL20210, CAL20260, CAL20500, CAL30000) are used in the automated parameters verification for this test.

4.3 CSE introduction

The EU CSE (Common Standards for Quantitative Electrocardiography) ECG database contains 3-lead measurement database of collection1 and collection2, 12-lead measurement

database of collection3 and collection4, and a diagnostic database of collection5. In which, the 12-lead measurement database contains 250 groups of interference data; Diagnostic database contains 1220 cases of short-term ECG recording. The primary development purpose of using 12-lead or 15-lead is to evaluate the performance of the automatic ECG analyzer. In addition to the normal data, the database also includes clinically confirmed ECGs of variety cases, such as left ventricular hypertrophy, right ventricular hypertrophy, every part of myocardial infarction and ventricular hypertrophy accompanying myocardial infarction. The database has made a great contribution to the study of electrocardiology, which is, the CSE group published a report on the recommended standard for general ECG measurements based on the investigation and study of the database, which has been widely recognized by the world.

CSE database diagnostic items:

Item	Number
Normal	382
Left ventricular hypertrophy	183
Right ventricular hypertrophy	55
Biventricular hypertrophy	53
Anterior myocardial infarction	170
Inferior myocardial infarction	273
Complex myocardial infarction	104
Synthetical accuracy	1220

4.4 Customized data

4.4.1 Data description

Customized data	Description
Total recording number	549
Race	Yellow race
Coverage of age, gender	Aged from 17 to 87, average age 57.23, standard deviation 21.32; 326 male, average age 55.54, standard deviation 19.81; 223 female, average age 59.70, standard deviation 22.63.
Sampling data	12-lead ECG data (I, II, III, AVR, AVL, AVF, V1, V2, V3, V4, V5, V6), sampling frequency of each channel: 1kHz, amplitude quantization: 2.4 μ V/LSB.
Remark	The interpretation conclusion of customized data is determined by the physician diagnostic results of cardiac catheterization and ultrasonic examination, and the ECG judgment result in physical examination, the details as blow: 1) Normal ECG Determined by the diagnostic result that judged as normal in cardiac

catheterization and ultrasonic examination, and the result that judged as normal in physical examination.

2) Atrium hypertrophy

Determined by the diagnostic results of ultrasonic examination.

3) Myocardial infarction and myocardial ischemia

Determined by the physician diagnostic results of cardiac catheterization.

4) Tachycardia, bradycardia, low voltage, axis

Determined by the diagnostic results of ultrasonic examination.

5) Conduction block

Determined by the physician diagnostic results of cardiac catheterization.

The standard of normal population in the customized database: physical examination is normal, no heart disease or other diseases that may affect cardiac functions or shape.

4.5 Data coverage of verification for automated interpretation

Analyzing the content of CSE diagnostic database and customized data, the overall condition and coverage of statistical samples are shown as below:

	Total					Male					Female				
	Youngest	Oldest	Average	SD	Total	Youngest	Oldest	Average	SD	Total	Youngest	Oldest	Average	SD	Total
Total	12	87	54.87	15.34	1769	14	87	54.33	14.33	1157	12	80	55.89	15.48	612

SD: standard deviation

No.	Items	Total					Male					Female				
		Youngest	Oldest	Average	SD	Total	Youngest	Oldest	Average	SD	Total	Youngest	Oldest	Average	SD	Total
1	No abnormal	12	87	47.39	18.21	585	14	79	46.37	17.51	234	12	87	48.07	18.32	351
2	Sinus mode Bradycardia	14	85	51.62	17.93	191	14	85	53.74	18.12	114	15	83	48.48	16.99	77
3	Sinus mode Tachycardia	19	79	50.26	16.97	78	23	76	53.33	18.76	25	19	79	48.81	17.65	53
4	Left atrium Hypertrophy	17	81	49.52	12.37	51	17	73	45.78	13.45	31	21	81	55.52	13.02	20
5	Right atrium Hypertrophy	18	76	48.71	15.34	43	19	71	47.21	14.36	27	18	76	51.24	15.29	16
6	Dual atrium Hypertrophy	26	77	51.32	16.49	22	26	75	49.91	16.13	15	29	77	54.34	15.47	7
7	QRS low voltage	33	67	52.44	15.83	5	52	52	52	0	1	33	67	52.55	15.99	4
8	Cardiac electric axis normal	12	87	48.97	19.06	733	12	85	46.52	18.98	304	14	87	50.71	19.26	429
9	Left axis deviation	27	73	49.48	15.71	168	28	73	48.73	14.27	86	27	71	49.66	15.09	83
10	Right axis deviation	36	77	52.76	14.68	107	36	72	51.85	15.11	56	37	77	53.76	14.79	51
11	Completeness Right Bundle branch block	46	78	56.97	11.53	28	46	75	55.86	10.97	15	50	78	58.25	11.20	13
12	Completeness Left Bundle branch block	44	79	56.99	10.93	32	44	73	55.72	10.21	18	52	79	58.62	9.74	14
13	No Completeness Right Bundle branch block	41	73	55.83	11.14	41	41	71	55.11	10.75	24	47	73	56.85	11.06	17
14	No Completeness Left Bundle branch block	43	71	55.76	10.38	47	43	69	54.36	10.27	31	48	71	58.47	10.67	16
15	V1 shows ESR type	37	75	56.81	15.77	13	37	74	56.16	15.46	10	40	75	58.98	17.69	3
16	Left anterior fascicular block	38	81	57.66	17.49	26	38	81	55.82	17.92	15	40	81	60.17	18.06	11
17	Left posterior fascicular block	41	78	56.78	16.88	18	43	78	55.16	17.93	12	41	77	60.02	15.69	6
18	Left ventricular hypertrophy	29	85	58.70	19.23	236	29	83	57.98	19.67	184	32	85	61.25	18.76	52
19	Right ventricular hypertrophy	27	84	59.31	19.54	108	27	79	58.09	20.04	71	31	84	61.65	19.33	37
20	1 intraventricular block	19	76	57.62	18.73	13	19	74	57.04	18.92	9	20	76	58.93	18.27	3
21	Early anteroseptal MI	48	83	63.48	10.34	10	48	80	61.39	10.29	7	59	83	68.26	12.84	3
22	Possible acute four-part anteroseptal MI	53	73	60.48	9.71	27	53	70	59.99	9.64	19	62	73	61.64	8.12	8
23	Old anteroseptal MI	55	82	65.37	9.17	26	55	80	64.78	10.08	20	58	82	67.34	9.68	6
24	Early anterior MI	47	76	61.26	10.41	77	47	71	60.52	9.62	53	55	76	63.34	9.77	24
25	Possible acute anterior MI	51	77	63.81	9.16	10	51	69	62.14	9.45	8	64	77	70.49	9.21	2
26	Old anterior MI	53	83	66.48	9.86	13	53	81	65.94	9.76	9	62	83	67.70	9.27	4
27	Early extensive anterior MI	52	75	60.35	11.74	24	52	72	59.88	11.52	17	58	75	61.49	12.36	7
28	Possible acute extensive anterior MI	55	79	63.81	12.34	16	55	75	61.58	10.63	10	58	79	67.53	11.21	6
29	Old extensive anterior MI	60	86	65.37	10.08	30	60	80	64.37	10.66	21	63	86	67.70	10.74	9
30	Early apical MI	39	71	60.36	12.47	15	39	69	60.18	12.76	10	47	71	60.72	11.28	5
31	Acute apical MI	43	77	63.78	11.57	21	43	74	62.69	12.03	16	50	77	62.23	12.46	4
32	Old apical MI	52	82	63.74	10.84	19	52	78	62.35	11.59	15	57	82	68.95	11.94	5
33	Early anterolateral MI	47	83	60.37	11.62	36	47	80	60.21	12.41	28	55	83	60.93	12.68	8
34	Possible acute anterolateral MI	55	80	63.77	10.66	9	55	75	62.18	11.62	7	58	80	69.54	10.88	2
35	Old anterolateral MI	56	82	64.82	10.73	14	56	76	64.05	11.62	10	60	82	66.75	10.47	4
36	Early high lateral MI	48	73	61.38	10.79	16	48	70	60.46	10.88	12	56	73	64.14	8.29	4

37	Possible acute high lateral MI	54	72	63.34	9.89	8	54	70	62.67	8.06	7	68	68	68.00	0	1
38	Old high lateral MI	55	77	65.17	11.44	23	55	74	64.09	10.12	17	38	77	68.23	9.94	6
39	Early inferior MI	46	74	61.31	12.55	31	46	70	61.02	11.81	22	50	74	62.02	11.73	9
40	Possible acute inferior MI	53	76	62.48	10.99	11	53	74	62.13	11.04	8	56	76	63.41	10.96	3
41	Old inferior MI	56	81	65.37	9.79	101	56	76	65.01	10.61	72	60	81	66.26	9.96	29
42	Early inferolateral MI	44	72	60.18	12.71	73	44	70	59.89	13.53	52	30	72	60.90	13.33	21
43	Possible acute inferolateral MI	50	78	63.47	10.77	29	50	75	62.49	11.62	20	55	78	65.65	11.78	9
44	Old inferolateral MI	56	83	66.56	9.83	28	56	80	65.41	9.96	19	60	83	68.99	8.24	9
45	ST depression, mild anteroseptal myocardial ischemia	43	74	62.34	12.77	7	43	70	62.47	11.99	5	30	74	62.02	16.94	2
46	ST depression, mild anterior myocardial ischemia	44	72	61.59	12.69	5	44	72	61.15	12.76	4	63	63	63.00	0	1
47	ST depression, mild extensive anterior myocardial ischemia	46	73	62.77	11.98	13	46	69	62.18	12.26	9	54	73	64.10	10.65	4
48	ST depression, mild apical myocardial ischemia	45	75	61.62	11.87	17	45	71	61.33	11.64	10	51	75	62.03	11.29	7
49	ST depression, mild anterolateral myocardial ischemia	44	74	60.97	12.65	25	44	72	60.07	12.39	15	30	74	62.32	12.04	10
50	ST depression, mild high lateral myocardial ischemia	46	81	64.36	12.31	21	46	79	63.94	11.82	16	53	81	65.70	12.74	5
51	ST depression, mild inferior myocardial ischemia	43	76	63.41	12.46	12	43	74	62.89	12.13	10	56	76	66.01	14.13	2
52	ST depression, mild inferolateral myocardial ischemia	39	72	62.76	12.38	20	39	69	62.11	12.12	13	44	72	63.97	13.37	7
53	ST depression, anteroseptal myocardial ischemia	49	78	65.61	11.62	4	49	78	65.24	14.81	3	67	67	67.00	0	1
54	ST depression, anterior myocardial ischemia	51	79	66.73	11.53	12	51	74	65.89	11.54	8	60	79	68.41	10.49	4
55	ST depression, extensive anterior myocardial ischemia	50	79	67.26	11.69	7	50	76	66.87	11.07	5	57	79	68.24	15.22	2
56	ST depression, apical myocardial ischemia	48	85	65.39	11.39	18	48	83	65.09	11.79	11	56	85	65.86	12.04	7
57	ST depression, anterolateral myocardial ischemia	52	83	66.92	10.97	13	52	83	66.42	12.32	7	52	81	67.53	11.69	6
58	ST depression, high lateral myocardial ischemia	53	84	65.74	10.88	16	54	84	65.16	12.36	9	53	82	66.49	11.47	7
59	ST depression, inferior myocardial ischemia	49	81	65.82	11.03	12	49	77	65.28	12.27	9	55	81	67.44	13.04	3
60	ST depression, inferolateral myocardial ischemia	49	82	66.04	11.14	6	49	79	65.49	16.98	4	52	82	67.14	21.02	2

⚠️ Note:

The heart abnormalities such as posterior myocardial ischemia, early posterior MI and old posterior MI are not included in the database. These abnormalities and other heart disorders not contained in above sheet won't be regarded as the judgment object for the verification of automated interpretation accuracy.

4.6 Data preprocessing

4.6.1 CTS preprocessing

The 16 cases (CAL05000, CAL10000, CAL15000, CAL20000, CAL20002, CAL20100, CAL20110, CAL20160, CAL20200, CAL20210, CAL20260, CAL20500, CAL30000, ANE20000, ANE20001, ANE20002) from CTS-ECG shall be processed for voltage conversion and frequency conversion for resampling as the applicable format in the system. Then cases will be imported to the device. After that, the verification of automated measurement parameters will be carried on.

4.6.2 CSE preprocessing

The cases (MA_0001~MA0125, D_0001~D_1220) from the CSE shall be processed for voltage conversion and frequency conversion for resampling as the applicable format in the system. Then cases will be imported to the device. After that, the case of MA_0001~MA0125 shall be used for the following verification of automated measurement parameters, and the case

of D_0001~D_1220 shall be used for the following verification of automated interpretation.

4.6.3 Customized data preprocessing

The customized initial case files shall be processed for voltage conversion and frequency conversion for resampling as the applicable format in the system. Then cases will be imported to the device. After that, the verification of automated interpretation will be carried on.

5. Process and Result of Verification

5.1 Verification of measurement function

5.1.1 Verification and Process for CTS measurement database

The cases (CAL05000, CAL10000, CAL15000, CAL20000, CAL20002, CAL20100, CAL20110, CAL20160, CAL20200, CAL20210, CAL20260, CAL20500, CAL30000, ANE20000, ANE20001, ANE20002) imported to the device shall be used to verify the automated measurement parameters.

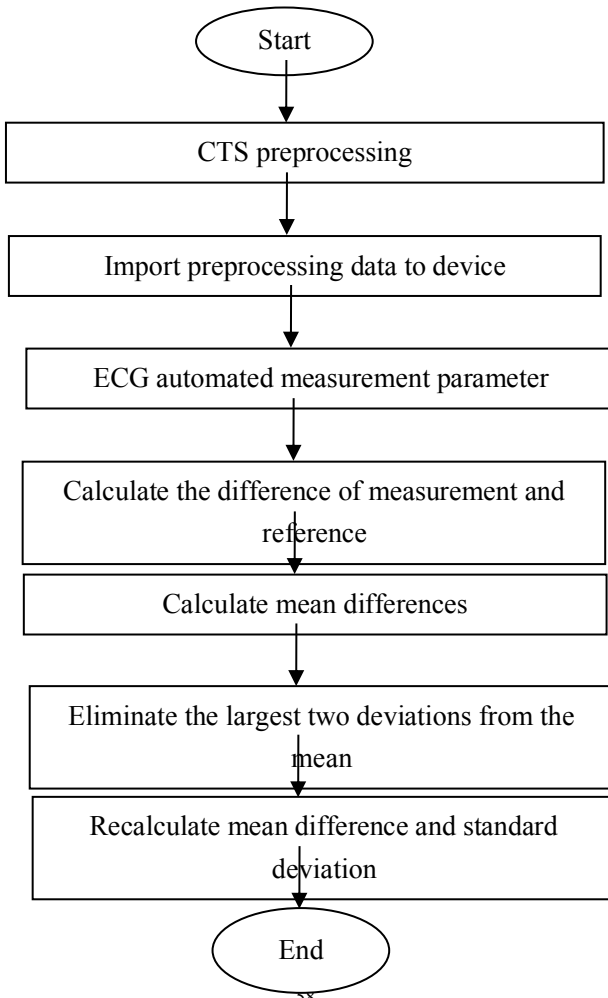

5.1.2 Verification and Process for CSE measurement database

Import the converted case files into the device, add appropriate database records, then waveform for all case files can be reviewed in the device, therefore the automated measurement parameters can be obtained.

Eliminate the cases existing obvious error for the diagnostic parameters (P-wave location is wrong) from the CSE database.

Make a comparison between the ECG analytical parameters (the beginning/end of P-wave, QRS-complex and T-wave) and the diagnostic parameters (the beginning/end of P-wave, QRS-complex and T-wave) provided by CSE database. Draw the two groups of waveform and mark the location of the beginning/end of P-wave, QRS-complex and T-wave corresponding to each case. The picture provides a visualized comparison, so the mean and standard deviation of the differences can be calculated. According to the requirement of IEC60601-2-51:2003 Medical electrical equipment - Part 2-51: Particular requirements for safety, including essential performance, of recording and analysing single channel and multichannel electrocardiograph, the four largest deviations from the mean shall be eliminated before recalculation of mean and standard deviation of the differences.

Flow diagram of CSE measurement database verification process

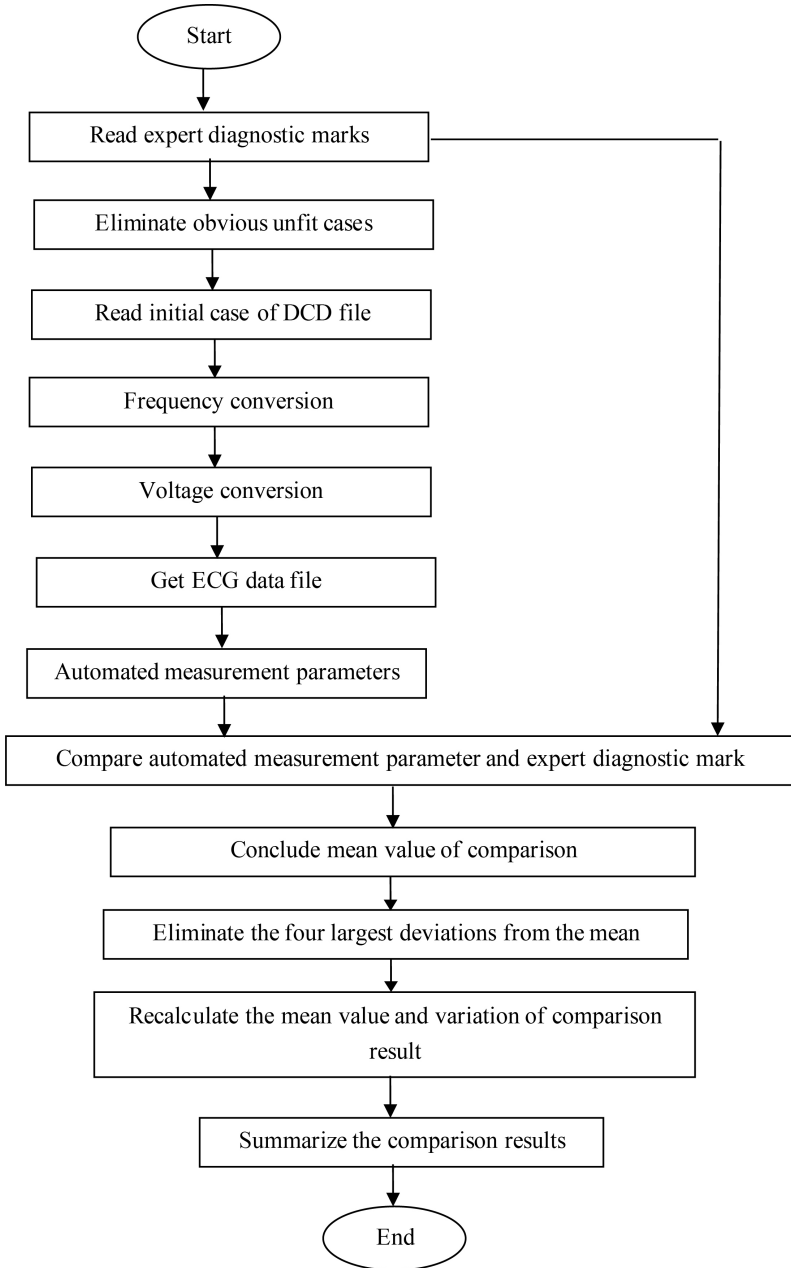

5.1.3 Verification results

5.1.3.1 Accuracy of amplitude measurements

Calibration and analytical ECGs shall be used to measure the amplitude value, the summary as follows:

Amplitude	Mean difference (uV)	Standard deviation (uV)
P-wave	-1.70	5.72
Q-wave	7.51	18.07
R-wave	-18.05	21.70
S-wave	7.77	18.58
ST-segment	0.15	4.24
T-wave	-5.81	8.03

 Note: In amplitude measurement, for large-amplitude ECG, such as CAL30000, it is necessary to adjust to 0.5 times the gain before testing.

5.1.3.2 Accuracy of absolute interval and wave duration measurements

Calibration and analytical ECGs shall be used to measure the global interval and wave duration (including Q-wave ,R-wave ,S-wave), the summary as follows:

Interval&Duration	Mean difference (ms)	Standard deviation (ms)
P-duration	-5.70	1.88
PQ-interval	-2.58	1.94
QRS-duration	-0.23	3.26
QT-interval	-6.70	4.37

5.1.3.3 Accuracy of interval measurements on biological ECGs

CSE database shall be used to evaluate the accuracy of interval measurements on biological ECGs, the summary as follows:

Interval&Duration	Mean difference (ms)	Standard deviation (ms)
P-duration	0.99	13.46
PR-interval	3.65	9.68
QRS-duration	-1.69	6.11
QT-interval	-2.32	20.69

5.1.3.4 Stability of measurements against NOISE

The test is carrying on according to MA-series data (008, 011, 013, 014, 015, 021, 026, 027, 042, 061) in CSE database.

Global measurement parameters	Type of added NOISE	Disclosed differences	
		Mean (ms)	Standard deviation (ms)
P-duration	High frequency	-5.65	12.33
P-duration	Line frequency	-0.25	12.71
P-duration	Base-line	-4.90	33.15
QRS-duration	High frequency	-0.95	5.13
QRS-duration	Line frequency	1.35	4.71

QRS-duration	Base-line	-1.55	7.68
QT-interval	High frequency	-14.55	6.51
QT-interval	Line frequency	-8.55	20.73
QT-interval	Base-line	36.20	64.47

The biological ECGs are fed into the device in form of digital signals, then the measurement value can be obtained by calculation.

Test condition:

- a) without NOISE
- b) with 25uV high frequency
- c) with 50uV peak to valley 50Hz/60Hz sinusoidal line frequency NOISE
- d) with 1mV peak to valley 0.3Hz sinusoidal base-line NOISE

For each NOISE level above, the differences of measurements between the NOISE-free ECGs and the ECGs with NOISE shall be determined. The two largest deviations from the mean shall be estimated before calculation of mean and standard deviation of differences.

5.2 Verification of interpretation function

5.2.1 Verification process

5.2.1.1 CSE diagnostic database

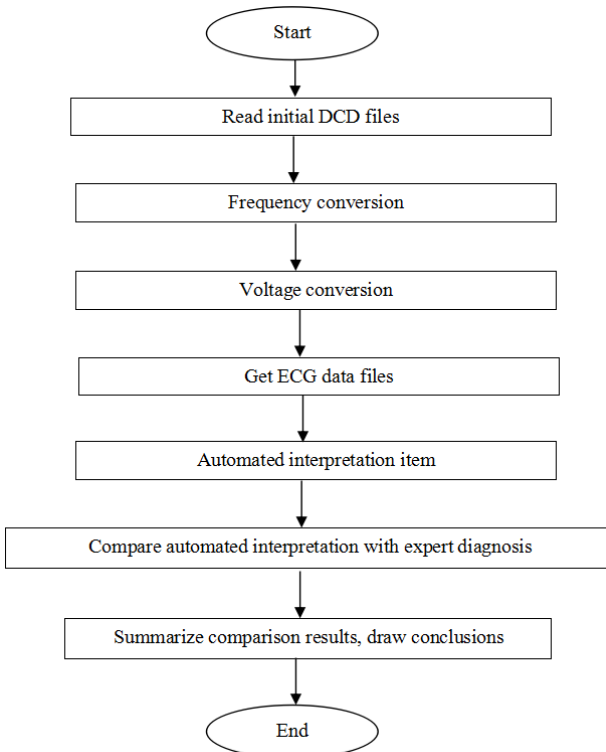

5.2.1.2 Customized database

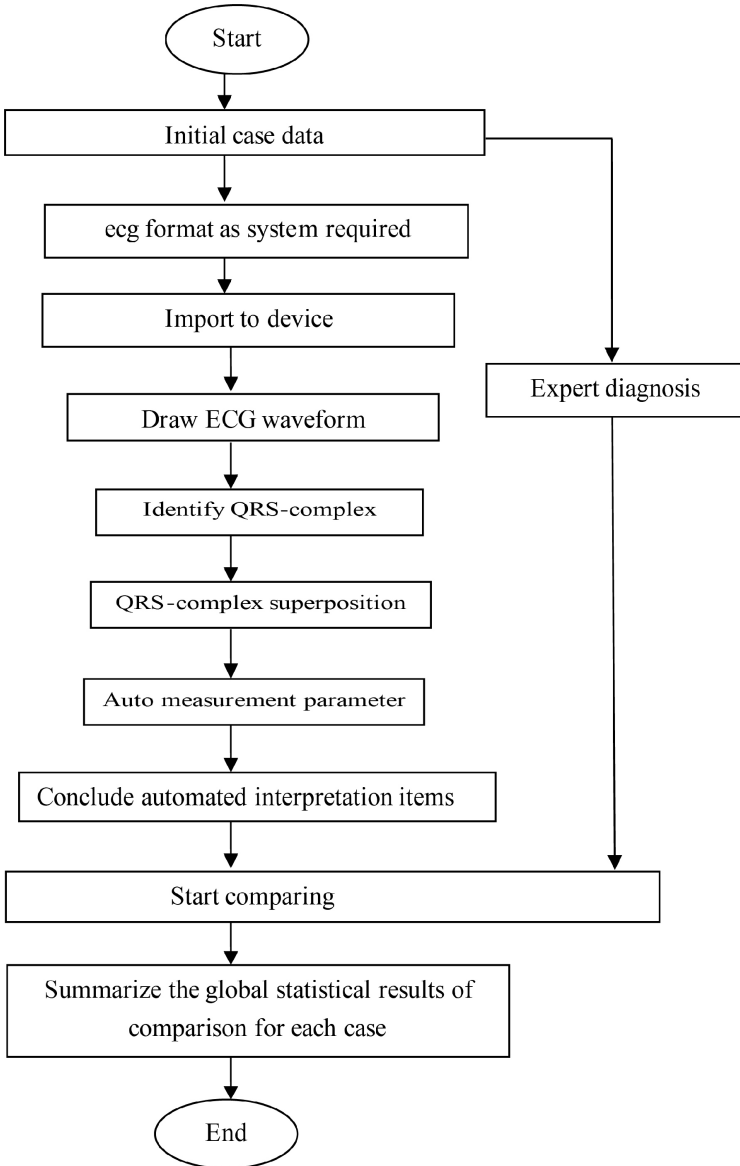

5.2.2 Verification results

No.	Item	ECGs number	Sensitivity %	Specificity %	Positive predictive value %
1	No abnormal	585	92.01	79.16	97.38
2	Sinus mode Bradycardia	191	96.68	99.73	98.64
3	Sinus mode Tachycardia	78	97.44	96.49	96.90
4	Left atrium Hypertrophy	51	51.09	99.89	81.82
5	Right atrium Hypertrophy	43	42.64	99.66	50.00
6	Dual atrium Hypertrophy	22	93.58	99.14	60.19
7	QRS low voltage	5	96.37	99.36	63.25
8	Cardiac electric axis normal	733	98.36	89.13	98.79
9	Left axis deviation	168	98.65	89.40	98.18
10	Right axis deviation	107	98.23	88.99	94.90
11	Completeness Right Bundle branch block	28	97.00	89.50	95.45
12	Completeness Left Bundle branch block	32	97.73	89.65	91.43
13	No Completeness Right Bundle branch block	41	96.86	89.83	82.35
14	No Completeness Left Bundle branch block	47	94.68	89.83	89.66
15	V1 shows RSR' type	13	90.32	91.14	65.12
16	Left anterior fascicular block	26	91.43	93.25	71.11
17	Left posterior fascicular block	18	89.29	97.37	52.63
18	Left ventricular hypertrophy	236	41.37	92.65	70.36
19	Right ventricular hypertrophy	108	39.75	93.47	65.39
20	I atrioventricular block	13	94.58	91.67	80.64
21	Early anteroseptal MI	10	83.33	99.94	90.91
22	Possible acute forepart anteroseptal MI	27	16.67	98.73	91.89
23	Old anteroseptal MI	26	92.00	98.90	86.47
24	Early anterior MI	77	93.90	88.22	71.96
25	Possible acute anterior MI	10	80.00	99.72	44.44
26	Old anterior MI	13	24.00	99.66	50.00
27	Early extensive anterior MI	24	79.67	99.43	41.18
28	Possible acute extensive anterior MI	16	81.82	99.66	75.00
29	Old extensive anterior MI	30	90.91	88.05	37.04
30	Early apical MI	15	88.32	87.21	88.54

31	Acute apical MI	21	78.12	78.66	53.85
32	Old apical MI	19	79.63	89.94	80.00
33	Early anterolateral MI	36	77.51	79.94	83.33
34	Possible acute anterolateral MI	9	28.57	99.77	33.33
35	Old anterolateral MI	14	70.00	93.60	50.00
36	Early high lateral MI	16	79.65	95.78	80.42
37	Possible acute high lateral MI	8	81.60	99.94	85.71
38	Old high lateral MI	23	81.82	99.66	60.00
39	Early inferior MI	31	88.89	95.00	40.00
40	Possible acute inferior MI	11	76.00	99.60	61.11
41	Old inferior MI	101	96.07	99.24	93.44
42	Early inferolateral MI	73	98.77	96.82	75.94
43	Possible acute inferolateral MI	29	11.11	99.94	50.00
44	Old inferolateral MI	28	84.62	99.83	78.57
45	ST depression, mild anteroseptal myocardial ischemia	7	75.36	99.55	46.67
46	ST depression, mild anterior myocardial ischemia	5	81.24	99.94	33.33
47	ST depression, mild extensive anterior myocardial ischemia	13	79.83	99.13	53.59
48	ST depression, mild apical myocardial ischemia	17	76.97	99.14	43.13
49	ST depression, mild anterolateral myocardial ischemia	25	77.54	99.08	37.64
50	ST depression, mild high lateral myocardial ischemia	21	80.64	99.14	47.39
51	ST depression, mild inferior myocardial ischemia	12	79.73	99.60	55.16
52	ST depression, mild inferolateral myocardial ischemia	20	80.59	99.26	50.61
53	ST depression, anteroseptal myocardial ischemia	4	85.41	99.72	44.44
54	ST depression, anterior myocardial ischemia	12	87.66	98.58	34.85
55	ST depression, extensive anterior myocardial ischemia	7	84.78	98.04	67.75
56	ST depression, apical myocardial ischemia	18	79.95	99.14	55.12
57	ST depression, anterolateral myocardial ischemia	13	87.42	98.97	59.09

58	ST depression, high lateral myocardial ischemia	16	90.06	99.31	57.14
59	ST depression, inferior myocardial ischemia	12	89.88	99.13	40.08
60	ST depression, inferolateral myocardial ischemia	6	91.39	99.16	50.47

Sensitivity: probability that a "True sample" would be determined as certain "Item" by automated interpretation function;

Specificity: probability that a "True unfit sample" would be determined as certain "Unfit item" by automated interpretation function;

Positive predictive value: probability that a determined "Unfit item" is a "True unfit item".

Appendix II EMC Guidance and Manufacturer Declaration

Warning

- The use of ACCESSORIES, transducers and cables other than those specified, with the exception of transducers and cables sold by the MANUFACTURER of the the device as replacement parts for internal components, may result in increased EMISSIONS or decreased IMMUNITY of the ME EQUIPMENT or ME SYSTEM.

The following cable types must be used to ensure that they comply with interference radiation and immunity standards:

No.	Name	Cable length (m)
1	Power cord	1.7
2	ECG lead cable	3.4
3	Potential equalization conductor	3.0

- Active medical devices are subject to special EMC precautions and they must be installed and used in accordance with these guidelines.
- Portable and mobile communication radiation equipment may affect the normal use the medical device.
- The device should not be used when they are close to or stacked with other equipment, if necessary, please observe and verify that they can operate normally in the configurations.
- Basic performance: Stability of working state: Waveform noise and measurement error appeared during measuring are automatically eliminated 10s after removing the interference, the working state of device are not changed, it could collect and record data continuously, and the waveform does not show obvious changes before and after the test.

Electromagnetic emission

Guidance and manufacture's declaration-electromagnetic emission		
The device is tended for use in the electromagnetic environment specified below. The purchaser or the user of the device should assure that it is used in such an environment.		
Emission test	Compliance	Electromagnetic environment-guidance
RF emissions CISPR 11	Group 1	The device uses RF energy only for its internal function. Therefore, its RF emissions are very low and are not likely to cause any interference in nearby electronic equipment.
RF emissions CISPR 11	Class B	The device is suitable for use in all establishments, including domestic establishments and those directly connected to the public low
Harmonic emissions	Class A	

IEC 61000-3-2		voltage power supply network that supplies buildings used for domestic purposes.
Voltage fluctuations/ flicker emission IEC 61000-3-3	Applicable	

Electromagnetic immunity

Guidance and manufacture's declaration-electromagnetic immunity			
The device is intended for use in the environment specified below. Buyer or operator should assure that it is used in such environment.			
Immunity test	IEC60601 test level	Compliance level	Electromagnetic environment-guidance
Electrostatic discharge (ESD) IEC 61000-4-2	±6kV contact ±8kV air	±6kV contact ±8kV air	Floors should be wood, concrete or ceramic tile. If floor is covered with synthetic material, the relative humidity should be at least 30%.
Electrical fast transient/burst IEC 61000-4-4	±2kV for power supply lines ± 1 kV for input/output line	±2kV for power supply lines ± 1 kV for input/output line	Mains power quality should be that of a typical commercial or hospital environment.
Surge IEC 61000-4-5	±1 kV lines to lines ±2 kV lines to earth	±1 kV lines to lines ±2 kV lines to earth	Mains power quality should be that of a typical commercial or hospital environment.
Voltage dips, short interruptions and voltage variations on power supply input lines IEC 61000-4-11	<5%UT(>95%dip in UT) for 0.5 cycle 40% UT(60%dip in UT) for 5 cycle 70%UT(30%dip in UT) for 25 cycle <5%UT(>95%dip in UT) for 5 sec	<5%UT(>95%dip in UT) for 0.5 cycle 40% UT(60%dip in UT) for 5 cycle 70%UT(30%dip in UT) for 25 cycle <5%UT(>95%dip in UT) for 5 sec	Mains power quality should be that of a typical commercial or hospital environment. If the user requires continued operation during power mains interruptions, it is recommended that the device be powered from an uninterruptible power supply or a battery.

Power frequency (50/60 Hz) magnetic field IEC 61000-4-8	3A/m	3A/m	Power frequency magnetic fields should be at levels characteristic of a typical location in a typical commercial or hospital environment.
NOTE: UT is the a.c. mains voltage prior to application of the test level.			

Guidance and manufacture's declaration-electromagnetic immunity			
The device is intended for use in the environment specified below. Buyer or operator should assure that it is used in such environment.			
Immunity test	IEC60601 test level	Compliance level	Electromagnetic environment -guidance
Conducted RF IEC61000-4 -3	3 Vrms 150kHz ~ 80MHz	3 Vrms	<p>Portable and mobile RF communications equipment should be used no closer to any part of the device, including cables, than the recommended separation distance calculated from the equation applicable to the frequency of the transmitter.</p> <p>Recommended separation distance</p> $d=1.2\sqrt{P}$ $d=1.2\sqrt{P} \quad 80\text{MHz}-800\text{MHz}$ $d=2.3\sqrt{P} \quad 800\text{MHz}-2.5\text{GHz}$ <p>Where P is the maximum output power rating of the transmitter in watts (W) according to the transmitter manufacturer and d is the recommended separation distance in meters (m).</p>
Radiated RF IEC61000-4 -3	3 V/m 80 MHz ~ 2.5 GHz	3 V/m	<p>Field strengths from fixed RF transmitters, as determined by an electromagnetic site survey, a should be less than the compliance level in each frequency range.b</p> <p>Interference may occur in the vicinity of equipment marked with the following symbol:</p> 

NOTE 1: At 80MHz and 800 MHz, the higher frequency range applies.

NOTE 2: These guidelines may not apply in all situations. Electromagnetic propagation is affected by absorption and reflection from structures, objects and people.

a Field strengths from fixed transmitters, such as base stations for radio (cellular/cordless) telephones and land mobile radios, amateur radio, AM and FM radio broadcast and TV broadcast cannot be predicted theoretically with accuracy. To assess the electromagnetic environment due to fixed RF transmitters, an electromagnetic site survey should be considered. If the measured field strength in the location in which the device or system is used exceeds the applicable RF compliance level above, the device should be observed to verify normal operation. If abnormal performance is observed, additional measures may be necessary, such as adjusting the direction or location of the device.

b Over the frequency range 150 kHz to 80 MHz, field strengths should be less than 3 V/m.

Recommended safety distance

Recommended separation distances between portable and mobile RF communications equipment and the device

The device is intended for use in the electromagnetic environment in which radiated RF disturbances are controlled. The customer or the user of the device can help prevent electromagnetic interference by maintaining a minimum distance between portable and mobile RF communications equipment (transmitters) and the device as recommended below, according to the maximum output power of the communications equipment.

Rated power of transmitter(W)	Separation distance according to power of transmitter (m)		
	150 k Hz – 80 MHz $d=1.2\sqrt{P}$	80 MHz – 800 MHz $d=1.2\sqrt{P}$	800 MHz – 2.5 GHz $d=2.3\sqrt{P}$
0.01	0.12	0.12	0.23
0.1	0.38	0.38	0.73
1	1.2	1.2	2.3
10	3.8	3.8	7.3
100	12	12	23

For transmitters rated at a maximum output power not listed above, the recommended separation distance in meters (m) can be estimated using the equation applicable to the frequency of the transmitter, where P is the maximum output power rating of the transmitter in watts (W) according to the transmitter manufacturer.

NOTE 1 At 80MHz and 800MHz, the separation distance for the higher frequency range applies.

NOTE 2 These guidelines may not apply in all situations. Electromagnetic propagation is affected by absorption and reflection from structures, objects and people.



Disposal: The product must not be disposed of along with other domestic waste. The users must dispose of this equipment by bringing it to a specific recycling point for electric and electronic equipment.

GIMA WARRANTY TERMS

The Gima 12-month standard B2B warranty applies.